

**Intergovernmental Oceanographic Commission**  
*Reports of Meetings of Experts and Equivalent Bodies*



**IOC Task Team on  
the Global Sea-Level  
Observing System (GLOSS)**

**Second Session**

Honolulu, USA, 19-23 October 1987

- 4 MARS 1988

**Unesco**

**Intergovernmental Oceanographic Commission**  
*Reports of Meetings of Experts and Equivalent Bodies*

**IOC Task Team on  
the Global Sea-Level  
Observing System (GLOSS)**

**Second Session**

Honolulu, USA, 19-23 October 1987

IOCARIBE/GE-TRODERP-I/3

Paris, 5 January 1988

English and Spanish only

In this Series, entitled

**Reports of Meetings of Experts and Equivalent Bodies**, which was initiated in 1984 and which is published in English only, unless otherwise specified, the reports of the following meetings have already been issued:

1. Third Meeting of the Central Editorial Board for the Geological/Geophysical Atlases of the Atlantic and Pacific Oceans
2. Fourth Meeting of the Central Editorial Board for the Geological/Geophysical Atlases of the Atlantic and Pacific Oceans
3. Fourth Session of the Joint IOC-WMO-CPPS Working Group on the Investigations of «El Niño» (*Also printed in Spanish*)
4. First Session of the IOC-FAO Guiding Group of Experts on the Programme of Ocean Science in relation to Living Resources
5. First Session of the IOC-UN(OETB) Guiding Group of Experts on the Programme of Ocean Science in relation to Non-Living Resources
6. First Session of the Editorial Board for the International Bathymetric Chart of the Mediterranean and Overlay Sheets
7. First Session of the Joint CCOP (SOPAC)-IOC Working Group on South Pacific Tectonics and Resources
8. First Session of the IODE Group of Experts on Marine Information Management
9. Tenth Session of the Joint CCOP-IOC Working Group on Post-IDOE Studies in East Asian Tectonics and Resources
10. Sixth Session of the IOC-UNEP Group of Experts on Methods, Standards and Intercalibration
11. First Session of the IOC Consultative Group on Ocean Mapping (*Also printed in French and Spanish*)
12. Joint IOC-WMO Meeting for Implementation of IGOSS XBT Ships-of-Opportunity Programmes
13. Second Session of the Joint CCOP/SOPAC-IOC Working Group on South Pacific Tectonics and Resources
14. Third Session of the Group of Experts on Format Development
15. Eleventh Session of the Joint CCOP-IOC Working Group on Post-IDOE Studies of South-East Asian Tectonics and Resources
16. Second Session of the IOC Editorial Board for the International Bathymetric Chart of the Mediterranean and Overlay Sheets
17. Seventh Session of the IOC-UNEP Group of Experts on Methods, Standards and Intercalibration
18. Second Session of the IOC Group of Experts on Effects of Pollutants
19. Primera Reunión del Comité Editorial de la COI para la Carta Batimétrica Internacional del Mar Caribe y Parte del Océano Pacífico frente a Centroamérica (*Spanish only*)
20. Third Session of the Joint CCOP/SOPAC-IOC Working Group on South Pacific Tectonics and Resources
21. Twelfth Session of the Joint CCOP-IOC Working Group on Post-IDOE Studies of South-East Asian Tectonics and Resources
22. Second Session of the IODE Group of Experts on Marine Information Management
23. First Session of the IOC Group of Experts on Marine Geology and Geophysics in the Western Pacific
24. Second Session of the IOC-UN(OETB) Guiding Group of Experts on the Programme of Ocean Science in relation to Non-Living Resources (*Also printed in French and Spanish*)
25. Third Session of the IOC Group of Experts on Effects of Pollutants
26. Eighth Session of the IOC-UNEP Group of Experts on Methods, Standards and intercalibration
27. Eleventh Session of the Joint IOC-IHO Guiding Committee for the General Bathymetric Chart of the Oceans (*Also printed in French*)
28. Second Session of the IOC-FAO Guiding Group of Experts on the Programme of Ocean Science in Relation to Living Resources
29. First Session of the IOC-IAEA-UNEP Group of Experts on Standards and Reference Materials
30. First Session of the IOCARIBE Group of Experts on Recruitment in Tropical Coastal Demersal Communities (*Also printed in Spanish*)
31. Second IOC-WMO Meeting for Implementation of IGOSS XBT Ship-of-Opportunity Programmes
32. Thirteenth Session of the Joint CCOP-IOC Working Group on Post-IDOE Studies of East Asia Tectonics and Resources

TABLE OF CONTENTS

<u>SUMMARY REPORT</u>	<u>Page</u>
1. OPENING	1
2. ADMINISTRATIVE ARRANGEMENTS	2
2.1 Adoption of the Agenda	2
2.2 Conduct of the Session	2
3. GLOSS NETWORK STATUS AND DEVELOPMENT	3
4. REQUIREMENTS OF TOGA AND WOCE FOR SEA-LEVEL MEASUREMENTS	8
5. GLOSS DATA MANAGEMENT AND ACTIVITIES OF INTERNATIONAL SEA-LEVEL CENTRES	10
6. PREPARATION OF IGOSS SEA-LEVEL PILOT PROJECT (ISLPP) FOR THE NORTH ATLANTIC AND PROPOSALS FOR SIMILAR PROJECTS IN THE INDIAN OCEAN	11
7. REQUIREMENTS FOR ABSOLUTE GEODETIC LEVELLING OF SOME GLOSS STATIONS	12
8. IOC AND OTHER REGIONAL ACTIVITIES RELATED TO GLOSS	13
9. TEMA RELATED ACTIVITIES	17
10. INTERNATIONAL GLOSS COORDINATION AND MANAGEMENT	19
11. PREPARATION OF REVISED GLOSS IMPLEMENTATION PLAN	20
12. WORK PROGRAMME FOR 1988-1989	22
13. ADOPTION OF THE SUMMARY REPORT	23
14. CLOSURE	23

ANNEXES

- I Agenda of the Meeting
- II List of Participants
- III Proposal on the IGOSS Sea-Level Pilot Project for the North Atlantic
- IV Requirements for Absolute Geodetic Levelling of some GLOSS stations
- V Next Generation Water Level Measurements Systems
- VI Proposed Work Programme for the Implementation of GLOSS for 1988-1989
- VII International Coordination of GLOSS
- VIII Sea-Level Training Courses
- IX Sea-Level Stations in the IOCARIBE Region
- X Sea-Level Stations of India
- XI List of Documents
- XII "Asean" Tide gauge locations
- XIII Activities of International Sea-Level Centres

1. OPENING

1 The meeting was opened at 8:30 a.m. the 19th October 1987 at the University of Hawaii at Manoa.

2 Prof. K. Wyrcki welcomed the participants on behalf of the University of Hawaii and NOAA. He expressed regrets that experts from the USSR and Indonesia, previously expected, could not now attend the meeting. Prof. Wyrcki noted that the scope and activities of GLOSS has greatly increased and expanded since the initiation of the programme. TOGA and WOCE programmes create additional strong demands for GLOSS. GLOSS is considered as a permanent programme and at this stage it faces the following problems: how to provide permanent real organization of GLOSS; what international governing body could be established to coordinate the programme implementation and its monitoring; and how to ensure permanent financing for GLOSS.

3 Dr. A. Tolkachev, IOC Senior Technical Secretary, welcomed the participants and on behalf of the Secretary of IOC expressed appreciation and thanks to NOAA and the University of Hawaii and Prof. K.Wyrcki, in particular, for hosting the meeting. He emphasized that one major task of this meeting is to up-date the GLOSS Implementation Plan, to be published in IOC Technical Series in 1988, and to prepare recommendations on the implementation of GLOSS, for submission to the Twenty-first Session of the IOC Executive Council to be held in March 1987 in Paris. Other major events related to GLOSS to which recommendation should be addressed are the First Session of the IOC-WHO Intergovernmental TOGA Board (Geneva, 2-6 November 1987) and the Ninth Session of the SSG for WOCE (November 1987, Washington) and the International WOCE Scientific Conference to be held in Paris in 1988.

4 Dr. D. Pugh was elected the Chairman of the Second Session of the Task Team. He also emphasized that GLOSS is a permanent multipurpose system and close interaction with TOGA and WOCE programmes will be extremely beneficial for future GLOSS development.

2. ADMINISTRATIVE ARRANGEMENTS

2.1 ADOPTION OF THE AGENDA

5 The Agenda was amended and adopted by the Task Team as shown in Annex I. List of Participants is shown in Annex II.

2.2 CONDUCT OF THE SESSION

6 Prof. K. Wyrcki proposed the time-table for the Session which included a visit to the TOGA Sea-Level Centre, Tsunami Warning Centre. It was endorsed by the Task Team. Dr. A. Tolkachev provided information on the documents for the Session. The List of Documents is shown in Annex XI.

3. GLOSS NETWORK STATUS AND DEVELOPMENT

7 Dr. A. Tolkachev presented the report on the status of implementation of GLOSS since the First Session of the Task Team in December 1985. The following major events in the development of GLOSS were highlighted:

8 The proposal for the development of the IOC Global Network of Sea-Level Stations, prepared by Prof. K. Wyrski and Dr. D. Pugh was adopted by the IOC Assembly at its Thirteenth Session in 1985 (Resolution XIII-7).

9 The Draft Implementation Plan for the Global Sea Level Observing System was prepared by the Task Team of experts on GLOSS at its First Session in December 1985.

10 The GLOSS Implementation Plan was approved in principle by the IOC Executive Council at its Nineteenth Session (Resolution EC-XIX.6) in 1986 and circulated to all Member States of IOC (document IOC/INF-663, 26 February 1986).

11 An updated GLOSS Implementation Plan 1985-1990 was prepared in October 1986 on the basis of comments and contributions received from Member States and circulated to Member States in November 1986 as document IOC/INF-663 rev., dated 30 October 1986.

12 Progress reports on the GLOSS developments were circulated to Member States in December 1985, February 1987, and July 1987.

13 The progress report on the GLOSS development (1986-July 1987) was presented to the meeting. More than 50 Member States have confirmed their participation in GLOSS and provided information on their GLOSS stations.

14 About 20 GLOSS sea-level stations in the Pacific and the Indian Ocean have been installed in 1985-1987 with the assistance of the University of Hawaii and NOAA, USA.

15 Two missions of experts to advise on setting up national GLOSS stations were organized with the support of IOC: in Mozambique by Portuguese experts and to countries of the West Africa by a French expert.

16 Five sea-level training courses on sea-level measurements and interpretation have been organized by the Bidston Observatory, UK and one by the People's Republic of China.

17 Implementation of GLOSS on a regional basis was considered in 1986-1987 by the IOC regional bodies for IOCEA, IOCARIBE, WESTPAC and SOC, and joint regional bodies, such as for El Nino.

18 In addition to the People's Republic of China, the Federal Republic of Germany, France, Portugal, Sweden, U.K., and U.S.A. have offered their assistance to developing countries in installation of tide gauges and training their specialists.

- 19 Twenty-seven countries have confirmed their needs for assistance in setting up their GLOSS stations (including provision of tide gauges, their installation and training of specialists).
- 20 Coordination and liaison have been provided with the international bodies involved in the planning and implementation of TOGA and WOCE programmes, International Hydrographic Organization, the International Geological correlation Programme, IAPSO etc.
- 21 Mr. S. Ragoonaden (Mauritius), presented a review of the current status of the GLOSS stations in the IOCINCWIO region. Since the First Session of the IOC Regional Committee for IOCINCWIO (4-9 October 1982, Nairobi), much progress has been achieved in the implementation of the GLOSS sea-level programme in the area. Training in sea-level measurement and data reduction has been provided at Bidston Observatory, UK, to the following countries in the region: Kenya, Madagascar, Mauritius, Seychelles, Somalia and Tanzania. In February 1986, two stations Pemba and Maputo in Mozambique were visited by a mission of Portuguese experts. With donations from the University of Hawaii and some technical assistance, tide gauges have been established in Mombasa (June 1986), Zanzibar (June 1986), Mauritius (July 1986) and Rodrigues (November 1986). A tide gauge has also been installed in Nosy Be with the assistance of a Unesco consultant. Mauritius has received a bubbler tide gauge from the University of Hawaii for Agalega and installation would start soon.
- 22 He further mentioned that sea-level data along the east coast of South Africa would be useful to monitor the strength of the Agulhas current. From a study he has made on historical data for Durban, he came to the conclusion that the station was not suitable for the monitoring of the coastal ocean dynamics as it was situated in a bay with only a very opening towards the open sea. The system, therefore, that consideration be given to the inclusion of East-London on the list of GLOSS stations for the region.
- 23 The Task Team was informed by Prof. K. Wyrteki that his technician was currently in Somalia for the installation of a tide gauge in Mogadiscio and two tide gauges would also be set up subsequently in Praslin (Seychelles) and Port Victoria (Seychelles). Sea-level data is being received regularly from Kenya, Tanzania and Mauritius.
- 24 The Task Team was further informed that Madagascar has received five tide gauges and is awaiting assistance to install them.
- 25 Dr. C. S. Joshi (India) informed on the participation of India in the GLOSS programme. In India, Geodetic and Research Branch of Survey of India, Dehra Dun has a long history of over 100 years of maintaining tide gauge network, collecting and processing their data mainly to determine datum for vertical control and to predict and publish tide tables for all the Indian and some adjacent ports and making these tide tables available to national and international users.
- 26 For world activity Geodetic and Research Branch is already supplying monthly mean sea-level data of 24 ports to PSMSL and by now data up to 1981 has been supplied (Annex X). But all the tide gauges are of an



old design and lot of time is taken in bringing graphical records to headquarters, reading them and working out mean sea level. GLOSS requirements are for measuring at 8 locations of which 5 are operational, whereas two are out of commission (Port Blair since 1964, Minicoy since 1977) and one at Nicobar is to be newly established. Since GLOSS requirement may include quick collection and processing, assistance from IOC of Unesco would be welcome to set up modern tide gauges at 3 places for which some Indian technicians could be trained for the operation/maintenance etc. This aspect needs immediate attention. India would very much like GLOSS to develop in its country especially because it will provide essential input to TOGA and WOCE and the objective of long term climatic predictions which is of major importance because of this year's erratic monsoon resulting in worse drought conditions not only in India but also in the monsoon regions of S.E. Asian countries. Of course, other allied objectives of study of vertical crustal movements, flood forecasting, storm-surge warnings, tsunami warnings, etc. are also of great importance.

27 Prof. G. W. Lennon (Flinders University, Australia) reported on the activities of Australia related to GLOSS, and in particular on ASEAN/Australia Program on Tides and Tidal Phenomena under the auspices of the Australian Development Assistance Bureau (Annex XII).

28 In November 1986, a two-week training programme was held in Singapore for tide gauge operators from the ASEAN region. Two trainees attended from each of 5 ASEAN countries (Thailand, Malaysia, Singapore, Indonesia and Philippines). The course content included: design of installation, installation, maintenance, datum control, use of specialized software and data processing on IBM P.C.s.

29 The course was planned and run by Prof. G.W. Lennon, of Flinders University (Bedford Park, South Australia 5042).

30 Contributions were made by Videgauge manufacturers and suppliers: Endeco and Steedman Ltd.

31 Prof. Lennon is currently (June 1, 1987 to May 31, 1988) operating on a one year "on-the-job" training course in Adelaide for 7 personnel from the ASEAN region. (Two from Thailand and the Philippines and one each from Malaysia, Singapore and Indonesia.)

32 An additional member from Indonesia and from Malaysia will join the course for approximately 4 months.

33 The course covers all aspects of tide and sea-level data processing, time-series analysis, frequency filtering, tidal analysis, prediction power spectral techniques, meteorological perturbations of sea level and sea-level phenomena from absolute levels, though sea-level trends, interannual and seasonal signals, tidal frequencies and non-linear tidal harmonics. Special attention is given to large scale ocean-atmosphere coupling and the significance of water exchange through the Indonesian straits.

- 34 Flinders University is charged with the task of setting up a sea-level data bank for the ASEAN region which incorporates the data from the array of 23 gauges currently being installed, but also the data from all the existing tide gauges. After two years, the Data Bank will be copied to each of the ASEAN countries. Rules have been established to govern the access to data in the Bank. Briefly those imply that Flinders University is allowed to copy material freely to a participating ASEAN country only but also to an external enquirer after receiving the permission of the national authority of the country in which the tide gauge resides.
- 35 With regard to Australian sea-level stations participating in GLOSS Prof. Lennon informed the meeting that 17 sea-level stations of Australia participating in the GLOSS programme. He suggested to delete stations Eucla (N54) from the list of GLOSS stations as it is impossible to install the station at this location.
- 36 Dr. G.A. Maul reported on GLOSS sea-level stations for the Caribbean sea and adjacent regions.
- 37 As a result of an expert consultation of physical oceanographers from nine Caribbean nations in 1986 and subsequent support of their recommendations by the IOCARIBE subcommission in 1986 and the IOC Assembly in 1987, a programme of circulation and climate variability has been established. This programme was further debated by a UNEP/RCU meeting in 1987, which resulted in the formation of a Task Team on Climate Change Impact in the Wider Caribbean Region. While the deliberations of the UNEP/RCU Task Team are not yet published, the IOC Workshop Report No. 45, "IOCARIBE Workshop on Physical Oceanography and Climate", is in agreement with both working groups, and is the primary source of the following recommendation.
- 38 In the GLOSS Implementation Plan (IOC/INF-633 rev.) and in the "IOCARIBE Regional Component of the Global Sea-Level Observing System" (SC-IOCARIBE-II/8 Annex 1), 20 GLOSS stations have been proposed for the IOCARIBE, 16 in the Atlantic and 4 in the Pacific. In concert with the preliminary GLOSS document, Dr. Maul prioritized 19 IOCARIBE stations. It should be noted however that at least twice this number is required for the plans set forth in Workshop Report No. 45.
- 39 Some stations have significant interest to an IOCARIBE member state for national needs. While sensitive to these needs, the first priority was given to the station's role in the global scheme. Two stations, Port au Prince, Haiti, and Puerto Cortes, Honduras, were chosen because preliminary calculations suggest sea level is rising approximately 1 meter/century. It will be important to verify that the bench marks are stable, and to continue searching for other stations with such large changes. Stations with long records were given priority.
- 40 Station pairs that are recommended for monitoring inflow/outflow patterns (superscripts refer to crustal plates; see Annex IX) are:

1. Straits of Florida:
  - A. Lake Worth, Florida 1
  - B. Settlement Point, Grand Bahamas Island 1
2. Grenada Passage:
  - A. Le Robert, Martinique 3
  - B. Charlottesville, Tobago 3
3. Windward Passage:
  - A. Punta Maisi, Cuba 1
  - B. Cap du Mole, St. Nicholas, Haiti 2
4. Anegada Guadeloupe Passages:
  - A. San Juan, Puerto Rico 2
  - B. Deshaies, Guadeloupe 3
5. Yacatan Strait:
  - A. Puerto Morales, Mexico 1
  - B. Cabo San Antonio, Cuba 1

41 Stations that are recommended for monitoring other secular changes (dates shown are from PSMSL records) are:

1. Port au Prince, Haiti 2 (1949-1961)
2. Puerto Cortes, Honduras 2 (1948-1968)
3. Pensacola, Florida 1 (1923-1980)
4. Corpus Christi, Texas 1 (1958-1969)
5. Veracruz, Mexico 1 (1953-1983)
6. Port Royal, Jamaica 2 (1954-1969)
7. Cristobal, Panama 2 (1909-1969)
8. Puerto Bolívar, Columbia 2 (new)
9. La Guaira, Venezuela 2 (1953-1975)

42 Mr. Yang Dequan (People's Republic of China) informed the participants on the activities of China in sea-level observations. He noted that NODC provides collection of tide data, their archiving and tidal prediction. He pointed out that China wishes to participate actively in the GLOSS programme. He suggested that the following stations be included in the GLOSS network: Nansha, (Guangdong), Xisha (Guandoug), Zhapo, Dalian, Xiamen (Fujian), Lusi (Jiangsu), Kanmen (Zhejiang), of which 6 are operational and 1 (Nansha) will be operational since 1990. He provided detailed information on those stations in accordance with the GLOSS Implementation Plan. China is willing to provide 2 pressure-type tide gauges to developing countries. In 1984 China organized with support of Unesco sea-level training course and is willing to organize a similar course

in the future if financial support is provided by the IOC. Sea-level data are archived at the NODC and efforts are being made to speed up data submission. Mr. Dequan suggested that the listing of GLOSS sea-level stations, included in the GLOSS Implementation Plan, need to be corrected by adding to the heading "country/territory".

- 43 Mr. A. Bolduc (Canada) reported that Canada participate in GLOSS. Eight sea-level stations have been included in the GLOSS network and Canadian Hydrographic Service implement the functions of the national GLOSS contact. He also noted that MEDS archives sea-level data and expressed its willingness to play a role of a SOC for ISLPP for the Atlantic Ocean.
- 44 Mr. J.-M. Verstraete (France) reported on the participation of French sea-level stations included in the GLOSS network. He noted that operation of sea-level stations in the Indian and Pacific oceans is conducted by the Hydrographic Service. He further noted that there is a great difficulty to install permanent tide gauge on Clipperton Island. Mr. Verstraete also reported on the sea-level stations of the IOCEA region (West Africa), where only a few stations are operational, namely in Ghana, Guinea, Ivory Coast and Congo.
- 45 Dr. W. Scherer (USA) reported that the USA supports greatly GLOSS implementation by maintaining the TOGA Sea-Level Center and SOC for ISLPP at the University of Hawaii and provides assistance to other countries in installing GLOSS stations. Particular attention is given to selection of key GLOSS locations to be equipped with new automatic systems for sea-level measurements and transmission of data via satellite and to establishment of absolute levelling network. 32 key GLOSS stations have been identified for those purposes (Annex V).
- 46 Prof. K. Wyrcki reported on the progress in developing GLOSS network in the Pacific and Indian Oceans. In the Pacific almost all GLOSS stations report regularly to the SOC for ISLPP center, of which 25 stations transmit sea-level data via satellite (GOES). Efforts will have to be made to install tide-gauges in Clipperton (France), San-Felix (Chile) and Minamitorishima (Japan). In the Indian Ocean during 1986-1987 the following stations have been installed with the help of the University of Hawaii and NOAA: Mombasa (Kenya), Dar-es-Salaam (Tanzania), Port Louis (Mauritius), Rodrigues (Mauritius), Male (Maldives), Gan (Maldives), Diego Garcia (UK), Muscat (Oman), Padang (Indonesia). Tide gauges in Mogadishu (Somalia) and Aldabra (Seychelles) will be installed soon. Two stations were installed in Indonesia: Padang and Bitung. He also confirmed his willingness to assist Madagascar, Oman and Indonesia, and India to install GLOSS sea-level stations.

47 The Task Team was informed that the Soviet Union had expressed its willingness to participate in GLOSS and proposed 8 sea-level stations for inclusion in the GLOSS Network: Petropavlovsk-Kamchatsky, Kaliningrad, Russkaya Gavan, Murmansk, Barentsburg, Tuapse, Nagaev, Yuzno-Kurilsk. Detailed information on those stations was submitted to the IOC Secretariat.

48 Chile has proposed to include in the GLOSS network the station: Base Antarctica Capitan Prat.

49 Having reviewed the status of the GLOSS network implementation the Task Team noted that gaps exist: particularly in the West Africa (IOCEA), the IOCARIBE region and in the Southern Ocean area to which particular attention should be given by Member States during the period 1988-1989:

- the West African region (IOCEA)
- the Caribbean and Adjacent Seas (IOCARIBE region)
- the Southern Ocean

#### 4. REQUIREMENTS OF TOGA AND WOCE FOR SEA-LEVEL MEASUREMENTS

50 Under this item, the Task Team reviewed the relation to the GLOSS implementation.

51 With regard to sea-level measurements in support of the TOGA Programme, Prof. Wyrtki, Director of the TOGA Sea-Level Centre, reported on the activities of the Centre. He pointed out that all GLOSS stations between 30°N and 30°S had been accepted as TOGA sea-level stations. This is reflected in the TOGA Implementation Plan. The TOGA Programme started in January 1985 and initially efforts were concentrated on the establishing of sea-level stations in the tropical Pacific. They are now expanding to cover the Indian Ocean. He noted that the TOGA Sea-Level Centre collects daily mean sea-level data from Pacific stations. Activities of the TOGA Sea-Level Centre are described in Annex XIII. Prof. Wyrtki pointed out that the expansion of the activity of the TOGA Sea-Level Centre to cover the whole tropical zone of the world ocean will need additional financial support. Prof. Wyrtki noted that the TOGA Sea-Level Centre provided data upon request to 85 scientists and organizations free of charge since 1985.

52 The participants then discussed the methods used by different countries for data filtering. Different views were expressed with regard to the standardization of methods for sea-level data filtering. It was agreed, however, that at this stage there is no need for standardization of these methods. The Task Team recommended that the participants provide the Secretariat of IOC with information on the bibliography with regard to sea-level data filtering methods to be made available to all GLOSS contact points. The participants were also invited to provide the Secretariat with the description of the sea-level filtering procedures for consideration at the third session of the Task Team.

- 53 The Task Team noted with satisfaction that sea-level observation activities in support of TOGA programme have been developed successfully in the Pacific and Indian Ocean. It noted, however, with concern that the tropical Atlantic situation is still unsatisfactory to meet the requirements of the TOGA programme. The Task Team also asked that ORSTOM (France) continue sea-level observation programme in the Tropical Atlantic, as follow-up of the Sequal-Focal Programme due to be terminated in 1984. These measurements may be continued for the duration of the TOGA Programme. The Task Team also wished to draw the attention of the First Session of the IOC-WMO Intergovernmental TOGA Board held in Geneva, 2-6 November 1987 and the Twenty-first Session of the IOC Executive Council, March 1988, to the need for more active actions by Member States to assist developing countries in establishing sea-level stations in the IOCEA and IOCARIBE regions to meet the scientific requirements of the TOGA programme and in particular for mutual collaboration of Member States in installing and maintaining sea-level stations in the tropical Atlantic.
- 54 Dr. D. Pugh presented the draft document "WOCE Sea-Level Requirements", prepared jointly with Dr. W. Nowlin taking into account the views expressed by the SSG for WOCE at its Eighth Session (Wormley, UK, 18-20 May 1987) and by the IAPSO meeting, chaired by Dr. D.E. Cartwright, held during the IUGG Assembly in Vancouver, Canada in August 1987. This document outlines that the first basic goal of WOCE requires sea-level measurements for two major purposes: (a) calibration of altimetric satellite missions; and (b) geostrophic computations of specific current, for example, through straits. Sea level will also serve as a check on the validity of numerical model outputs. The earlier records of sea level collected by PSMSL can also serve as a check on the output when the models developed during WOCE are run for previous decades. In general, hourly or more frequent observations will be required. For locations at mid- and high-latitudes, tide gauge measurements must be supplemented with sea-level atmospheric pressure observations. It is highly desirable that multiple tide gauge sensors are used to check the outputs and to cover for instrument failures. It was proposed that two types of sea-level centres be established within the framework of WOCE: one dealing with the A - (altimetry) network data with two month delay, and another with the complete GLOSS network, producing homogeneous data set with a delay of 12-18 months.
- 55 The Task Team reviewed carefully this draft document and discussed in detail the adjustment to GLOSS which would be necessary to assist in the development of WOCE. It noted that the advent of WOCE provided an opportunity for encouraging Member States to make additional resources available for the measurement of sea-level, and that such resources would be important for the long-term development of GLOSS.
- 56 The Task Team asked Dr. Pugh to convey the following comments and proposals to the WOCE-SSG for consideration in the preparation of the WOCE Implementation Plan:
- (1) For the two-month A-network it would be desirable to establish a small number of centres, each responsible for a particular region or ocean. Specifically, centres would be required for the Atlantic, Pacific, Indian and Southern Ocean.

- (ii) The long-term 12-18 month centre data analysis to examine of GLOSS stations for global studies would be a valuable contribution to GLOSS development.
- (iii) High-quality air-pressure and winds data should be collected alongside sea-level measurements.
- (iv) WOCE participants should be encouraged to contribute to the development of sea-level measurements so that GLOSS becomes more fully operational.
- (v) Several additional station pairs (particularly in the Caribbean Sea and the Antarctic Ocean) and gauges which could contribute to the A-network were identified.
- (vi) Special efforts would be needed to establish the necessary measurement stations in the Antarctic.
- (vii) The use of Global Telecommunication System of WMO for international data exchange should be considered.

57 For future communication between the GLOSS, TOGA and WOCE programmes the Task Team requested Dr. Pugh, Chairman of the Task Team, to provide liaison with the SSG for WOCE and Prof. Wyrtki, Director of the TOGA Sea-Level Centre, to provide liaison with international bodies involved in TOGA implementation.

5. GLOSS DATA MANAGEMENT AND ACTIVITIES OF INTERNATIONAL SEA-LEVEL CENTRES

58 The Task Team reviewed the present arrangements for sea-level data management, as described in the GLOSS Implementation Plan (Doc. IOC/INF-663 rev.) and the activities of international sea-level data centres:

- TOGA Sea-Level Centre
- Specialized Oceanographic Data Centre for the IGOS5 Sea-Level Pilot Project in the Pacific Ocean (SOC for ISLPP)
- Permanent Service for Mean Sea Level (PSMSL)

59 Prof. Wyrtki reported on the activities of the TOGA Sea-Level Centre and the SOC for ISLPP and Dr. Pugh reported on the activities of the Permanent Service for Mean Sea Level (PSMSL) (Annex XIII).

60 In addition to the information and comments expressed under the Agenda item 4, Prof. Wyrtki wished to emphasize that the SOC for ISLPP started its activities from 1984. It has greatly increased its activities

of collecting sea-level data from all countries of the Pacific ocean basin and it plans to issue new sea-level products on the basis of data received from more than 70 stations. Sea-level data from satellite altimetry will be incorporated in the future activities of the SOC for ISLPP.

61 Dr. Pugh emphasized that the flow of sea-level data to PSMSL had significantly increased since the launching the GLOSS programme.

62 Scientists of the PSMSL have prepared the Manual on Sea-Level Measurements and Interpretations that has been translated into four languages and published by IOC in the IOC Series Manuals and Guides. It was proposed that the IOC Secretariat investigate further possibility to translate this Manual into Portuguese and Arabic languages.

63 PSMSL since 1983 organize annual sea-level training courses attended by more than 20 trainees from many developing countries (Annex VIII).

64 Dr. Pugh informed the Task Team that the PSMSL has recently published "Data Holdings of the PSMSL" which itemizes the total holdings of the PSMSL as of January 1987.

65 The Task Team noted with satisfaction the activities of the international sea-level centres and recommended that:

- (i) IOC Secretariat continue monitoring sea-level data submissions to those sea-level data centres twice a year jointly with the sea-level centres;
- (ii) Member States be encouraged to provide timely submission of sea-level data to the international centres in accordance with the GLOSS implementation plan;
- (iii) International sea-level data centres be requested to expand their feedback in the form of sea-level data products (similar to SOC ISLPP) in order to encourage participation of countries and individual scientists in sea-level programmes.

6. PREPARATION OF IGOSS SEA-LEVEL PILOT PROJECT FOR THE NORTH ATLANTIC AND PROPOSALS FOR SIMILAR PROJECTS IN THE INDIAN OCEAN

66 Mr. A. Bolduc (MEDS, Canada) presented a proposal on the sea-level Pilot Project for the North Atlantic following the proposal made at the Thirteenth Session of the IOC Assembly and the offer of Canada, expressed at the Fourteenth Session of the IOC Assembly to initiate such a project. The Pilot Project will undertake to acquire on a monthly basis the monthly mean sea-level data of tide gauges located around and in the North Atlantic Basin in order to obtain a monthly synoptic data set of mean sea levels from which monthly mean sea-level charts will be produced and disseminated. Proposal for this project is shown in Annex III.



67 The Task Team strongly supported the implementation of the proposed pilot project for the North Atlantic and recommended the following actions:

- (i) to extend the access of the Pilot Project till 30°S to cover the area of the TOGA programme, including IOCARIBE and IOCEA regions;
- (ii) to present this proposal in consultation with the Chairman of the Joint IOC-WMO Technical Committee for IGOSS to the Twenty-first Session of the IOC Executive Council for approval;
- (iii) to prepare in cooperation with PSMSL, IOCARIBE and IOCEA implementation plan for the ISLPP for the North and Tropical Atlantic, taking into account the experience of the SOC ISLPP for the Pacific Ocean;
- (iv) to circulate the plan to participating Member States in order to initiate Project in 1988.

68 The Task Team also considered the need and possibility for similar Pilot Project in the Indian Ocean. While recognizing the importance of such a project in the Indian Ocean, the Task Team felt that at present it is premature to initiate such a project due to the lack of the availability of sea-level data. The Task Team pointed out that implementation of the similar pilot project in the Indian Ocean will depend on (i) availability of data from sea-level stations of India on real-time basis and (ii) installation of automatic sea-level stations on islands of the Indian Ocean. The Task Team recommended that this matter should be given particular consideration at its Third Session. Meanwhile this question should be further investigated with other countries of the IOCINCWIO and IOCINDIO regions.

#### 7. REQUIREMENTS FOR ABSOLUTE GEODETIC LEVELLING OF SOME GLOSS STATIONS

69 The Task Team considered the need for geodetic locating of some GLOSS stations and the potential for use of the Global Positioning System (GPS) and Very Long Interferometry System (VLBI) and other similar systems (DORIS), in order to distinguish between vertical movements of land and sea.

70 Dr. W.E. Carter (USA) presented the report on GLOSS relation to VLBI/GPS systems and linking some GLOSS stations into absolute VLBI/GPS framework in order to measure absolute sea level, both the vertical land motion at the individual sea-level stations and the local sea-surface position. This report is reproduced in Annex IV.

71 It was noted that within the next year about 50 GLOSS stations will be equipped with VLBI/GPS techniques by NOAA and that other countries will be involved in such activities. The "DORIS" system by France was mentioned in this regard to be tied to VLBI system.

72            The Task Team noted the great importance for absolute levelling of some GLOSS sea-level stations with the use of VLBI/GPS and other similar systems. It agreed that IAPSO Commission for mean sea-level tides could be appropriate body to deal with this matter and requested that the Chairman of this Commission, Dr. Pugh, ensure proper liaison between geodetic and oceanographic community dealing in particular with the GLOSS.

73            Under this item Dr. Scherer informed the Task Team on the development and testing of next generation water level measurement system to be used within the framework of GLOSS, Tsunami warning system, storm surge monitoring and other sea-level monitoring systems. Description of this system is given in Annex V. The Task Team was informed that about 32 such stations will be installed next year in the GLOSS locations shown in Annex V. The Task Team welcomed the development of such systems within the framework of GLOSS recognizing that the data obtained from automatic stations would be available to national services and international communities throughout the satellite communication system.

#### 8.            IOC AND OTHER REGIONAL ACTIVITIES RELATED TO GLOSS

74            Dr. Tolkachev presented document IOC/GLOSS-II/11 "IOC Regional Activities related to GLOSS" which provides information on the decisions of the IOC governing bodies regarding the implementation of GLOSS by IOC regional subsidiary bodies and action taken by the IOC regional bodies in 1986-1987 to implement the GLOSS regional components.

75            The IOC Assembly at its Thirteenth Session (March 1985) by Resolution XIII-7 "requested the regional subsidiary bodies of the Commission, as well as other cooperating regional bodies, to give priority to the implementation of sea-level observing networks in their respective ocean regions". By its Resolution EC-XIX.6 the IOC Executive Council at its Nineteenth Session "invited the Chairmen of all IOC regional subsidiary bodies to consider at their forthcoming sessions the development of regional sea-level projects as components of GLOSS, and to submit the resulting proposals to the IOC Assembly". Furthermore, the IOC Assembly at its Fourteenth Session (17 March - 1 April 1987) agreed that IOC regional bodies are a proper framework for implementation of GLOSS in their respective regions and invited the Chairmen of IOC regional subsidiary bodies to consider the implementation of the regional components of GLOSS at their forthcoming sessions and to consider the designation of regional coordinators for GLOSS, to promote, inter alia, sea-level data submission to international centres and the installation of GLOSS sea-level stations in their respective regions.

76            The development of regional networks of sea-level stations was considered at the First Session of the IOC Regional Committee for the Central Eastern Atlantic (IOCEA-I, January 1987), the Second Session of the IOC Sub-Commission for the Caribbean and Adjacent Regions (IOCARIBE-II, December 1986), the Fifth Session of the IOC Regional Committee for the

Southern Ocean (IOCSOC-V, June 1987), the Fourth Session of the IOC Regional Committee for the Western Pacific (WESTPAC-IV, June 1987), the Fifth Session of the Joint Working Group on the Investigations of "El Nino" (November 1986).

77 The regional components of GLOSS will be discussed at the forthcoming sessions of the IOC Regional Committee for Cooperative Investigations in the North and Central Western Indian Ocean (IOCINCWIO-II, December 1987) and the IOC Regional Committee for the Central Indian Ocean (IOCINDIO-I, April 1988).

78 The development of regional sea-level network in the area of the Red Sea and Gulf is coordinated by the Unesco Division of Marine Sciences.

#### The Central Eastern Atlantic

79 Mr. J.-M. Verstraete reported on the studies of seasonal and interannual sea-level changes undertaken by ORSTOM with the use of pressure type tide gauges initiated within the framework of FOCAL/SEQUAL programmes (1982-1984) and continued after 1984 in support of TOGA programme.

80 The Task Team wished to emphasize the importance of continuation of such studies in the Tropical Atlantic.

81 The Regional Committee on IOCEA (January 1987) established a project on the implementation of the IOCEA regional component of GLOSS as approved by IOC Assembly at its Fourteenth Session (Resolution XIV-11). All countries of the region expressed interest in participating in the project. However, most of them need assistance in provision of tide gauges, their installation and training of specialists.

82 The Task Team requested the Secretariat to approach countries, which expressed willingness to assist other countries, i.e., Federal Republic of Germany, France, Portugal and Sweden, with the request to combine their efforts in assisting countries of the IOCEA region, in setting up 5-7 GLOSS sea-level stations. The Secretariat was also requested to investigate possible cooperation with UNEP in this area.

#### The Caribbean Sea and Adjacent Regions

83 The establishment of the network of sea-level stations in the Caribbean Sea and Adjacent Regions was discussed at the IOCARIBE Workshop on Physical Oceanography and Climate and the Second Session of the IOC Sub-Commission for the Caribbean and Adjacent Regions (Havana, Cuba, 8-13 December 1986). Upon recommendation of the IOCARIBE-II, the IOC Assembly decided (Resolution XIV-10) "to establish the IOCARIBE IOC-IMO-UNEP Group of Experts on Physical Oceanography and Climate, which should, inter alia, assist in establishing an improved network of stations each to record sea level, sea-surface temperature and salinity, wave spectra and other meteorological parameters". At the Fourteenth Session of the IOC Assembly the Delegate of Cuba offered to host a workshop on strengthening the regional component of GLOSS.

84 Dr. Maul reported on the planning of the IOCARIBE network of sea-level stations. A proposed IOCARIBE network of sea-level stations shown in Annex IX. 19 GLOSS gauges are proposed for the IOCARIBE. These gauges are distributed so as to optimize information on geostrophic surface currents, coastal erosion, storm surge, pollutant trajectories, and climate change impact. Monthly mean sea levels from these gauges are planned to be incorporated into an IGOSS Sea-Level Pilot Project for the North Atlantic, which is proposed by the Marine Environmental Data Service (MEDS) of Canada.

85 The 19 GLOSS stations are considered a minimum number required for the global aspects of the IOCARIBE. Regionally, twice that number is required as outlined in the Workshop Report No. 45. Many of the 40-odd stations required in the Regional Programme are already operational, but approximately twelve new sites need to be established. The IGOSS project planned by MEDS will incorporate all 40 stations in the monthly product. The Task Team accepted the scientific basis for a proposed IOCARIBE network of sea-level station and recommended that this proposal should be coordinated through the IOCARIBE Secretariat with the countries of the region. It also recommended that Dr. Maul confirmed cooperation on this matter with the IOCARIBE Secretariat. It further encouraged participation of countries of the region in the proposed ISLPP for the North and Tropical Atlantic.

#### The Western Pacific Ocean

86 The implementation of the WESTPAC regional component of GLOSS was discussed at the Fourth Session of the IOC Regional Committee for WESTPAC (Bangkok, Thailand, 22-26 June 1987). Dr. Pugh who participated in this Session reported on the outcome of the discussion on GLOSS. The Regional Committee expressed its support for GLOSS efforts, it welcomed the cooperative effort in the ASEAN-Australian Project (Annex XII) and stressed the need for training and assistance for the scientists and personnel from interested developing countries from the region. The Regional Committee did not recommend any specific actions regarding GLOSS implementation in the region and requested the IGOSS regional coordination mechanism to assist in coordinating GLOSS activities in the region. Dr. Pugh noted that the WESTPAC region covers large oceanic areas with different scientific and practical interest for sea-level measurements. There might be however possibility of a sub-regional cooperative sea-level activity particularly:

- (i) in the northern part of WESTPAC associated with Kuroshio current with possible participation of China, Japan, and other countries;
- (ii) in the central WESTPAC region to study water exchange between Pacific and Indian Oceans with possible participation of Indonesia, Malaysia, Singapore and other countries; and
- (iii) the southern WESTPAC region to study currents and energetic eddy zones with possible participation of Australia and New Zealand.

87 The Task Team felt that such approach could be advantageous for the successful implementation of GLOSS taking into account scientific and practical interests of the countries of the region and requested the

Secretariat to contact countries of the region to identify their interest and possible participation in the proposed sub-regional sea-level projects.

#### The Southern Ocean

88 The IOC Regional Committee for the Southern Ocean at its Fifth Session (Paris, June 1987) considered the implementation of the regional component of GLOSS in the Southern Ocean. It recognized the extreme difficulty in establishing and operating sea-level gauges in this area and recommended that Member States working in the antarctic area be requested to provide the IOC Secretariat, by March 1988, with information on their experience, the methods and technology used or planned to be used in sea-level measurements in such hostile conditions. The Task Team was informed by Dr. Tolkachev that such a request was sent to a number of the IOC Member States (IOC Action Addressees, GLOSS Contact Points and Institutions working in the Southern Ocean areas).

89 Prof. Lennon noted that Australia might consider playing a leading role in promoting sea-level measurements in the Southern Ocean and that he would investigate this matter and inform the Secretariat.

90 The Task Team confirmed the opinion expressed in the Draft Implementation Plan, that it would be highly desirable to initiate consultation of experts on the methods and technology for sea-level measurements in such hostile conditions and requested the Secretariat jointly with the Chairman of the Task Team investigate the possibility to organize such expert consultations.

#### The ERFEN Area

91 The Joint IOC-WMO-CPPS Working Group on the investigation of "El Nino" at its Fifth Session (Guayaquil, Ecuador, 3-5 November 1986) considered the development of the regional component of GLOSS. The Task Team noted with satisfaction that all countries of the region participate actively in the GLOSS programme and provide data to the SOC for ISLPP and TOGA Sea-Level Centre.

#### The North and Central Western Indian Ocean

92 The Second Session of the IOC Regional Committee for the North and Central Western Indian Ocean (IOCINCWIO) will be held in December 1987 at Arusha, Tanzania. The development of the regional component of GLOSS will be discussed at this meeting. The Task Team noted with great satisfaction that 8 tide gauges have been already installed and two more will be installed soon with the assistance of the University of Hawaii and NOAA. The Task Team requested Mr. Ragoonaden, who planned to attend the session, to make a presentation on GLOSS and encourage further participation of countries of the region in GLOSS.

The Central Indian Ocean

93 The First Session of the IOC Regional Committee for the Central Indian Ocean will be held in April 1988 in Pakistan. The Task Team requested Dr. Joshi and Dr. Pugh to make presentations on GLOSS at the meeting and to encourage participation of countries of the region in the GLOSS.

94 The Task Team was also informed that some initiatives are being taken by the Unesco Division of Marine Sciences in cooperation with PERSGA and ROPME to implement regional network of sea-level stations in the Red Sea and Gulf area.

9. TEMA RELATED ACTIVITIES

95 TEMA activities related to GLOSS include:

- (i) provision of instruments and their spare parts;
- (ii) assistance in provision of advice on selection of sites for GLOSS stations;
- (iii) assistance in installation of tide gauges;
- (iv) assistance in training of technicians and specialists;
- (v) support for attendance of international seminars and meetings;
- (vi) provision of documents related to GLOSS

96 The IOC Assembly at its Thirteenth Session (1985) through Resolution XIII-7, at its Fourteenth Session (1987) through Resolution XIV-2 and the IOC Executive Council at its Nineteenth Session (1986) through Resolution EC-XIX.6, urged Member States of IOC to provide such assistance and support to developing countries.

97 The Task Team noted that such assistance is provided either through bilateral or multilateral agreements between countries or through IOC Voluntary Cooperation Programme and other IOC activities.

98 Since the approval of the GLOSS programme in 1985 a number of actions have been taken:

- (i) almost 20 tide gauges have been installed in the Pacific and Indian Oceans with the help of the NOAA and the University of Hawaii;
- (ii) the University of Hawaii with support of NOAA has expressed willingness to assist further countries of the Indian Ocean in setting up GLOSS stations (India, Indonesia, Madagascar, Seychelles, Somalia and others);
- (iii) the People's Republic of China has offered two pressure-type gauges and assistance in their installation. This offer has been addressed through IOC to Somalia and Sri Lanka;

- (iv) France has helped Brazil to install several pressure-type tide gauges;
- (v) Sweden has confirmed its willingness to offer 10 tide gauges (OTT type) for developing countries;
- (vi) the Federal Republic of Germany expressed its readiness to offer an expert mission of long duration (half a year) to developing countries at its expense to assist in the installation, reactivation or repair of tide gauges;
- (vii) Portugal has established cooperation with Cape Verde, Mozambique and Sao Tome and Principe in the installation of GLOSS stations and the training of specialist;
- (viii) two missions of experts to advise on setting up national GLOSS stations were organized in 1986 with IOC support to Mozambique (experts from Portugal) and to countries of the IOCEA region (expert from France: Mr. J.-M. Verstraete);
- (ix) Australia provides assistance to ASEAN countries in setting up the sea-level stations and training specialists (Indonesia, Malaysia, Philippines, Singapore and Thailand);
- (x) since 1983 regular annual sea-level training courses have been organized by PSMSL (Bidston Observatory, UK) with the support of IOC, which have been attended by 18 trainees;
- (xi) in 1984 the People's Republic of China organized sea-level training course attended by 12 specialists;
- (xii) France has offered to organize sea-level training course in 1988 for French speaking countries.

99            The Task Team noted with satisfaction actions and initiatives by many countries to assist developing countries to enable them to participate in the GLOSS activities.

100           The Task Team recognized that the countries of the IOCEA region had expressed their willingness to participate in GLOSS and at the same time great need for assistance in setting up GLOSS stations. The Task Team noted also willingness to provide assistance expressed by France, Federal Republic of Germany, Portugal and Sweden. The Task Team recommended that those countries be requested to undertake joint mission to assist countries of the IOCEA region. It recommended to the IOC Secretariat to organize a meeting of a group of experts consisting of specialists from France, Federal Republic of Germany, Portugal and Sweden and the Chairman of the IOCEA to identify priorities in establishing GLOSS stations in the region and prepare a joint plan of actions to establish GLOSS stations in the region. Priority should be given to the sites shown in Appendix 1 of Annex VI and the working gauges which needed upgrading.

101 The Task Team requested the Secretariat to specify further requirements for assistance from other regions (IOCARIBE, South America) and address those requirements to individual potential donor countries.

102 Mr. Ragoonaden wished to point out that assistance will be needed by recipients of assistance also after the installation of tide gauges, particularly with regard to provision of spare parts and regular training of specialists. He also proposed that IOC Secretariat should contact all specialists who attended sea-level training courses in order to find out whether they are now involved in sea-level measurements within the framework of GLOSS. The Task Team supported this proposal.

103 The Task Team wished to draw the attention of the IOC Executive Council to the need for further strengthening these activities by IOC Member States in order to speed up implementation of GLOSS, and requested the IOC Executive Council to give priority in setting up GLOSS stations in 1988-1989 as shown in the Proposed Work Programme (Appendix 1 of Annex VI).

#### 10. INTERNATIONAL GLOSS COORDINATION AND MANAGEMENT

104 Dr. Tolkachev presented the document IOC/GLOSS-II/13 which provides information on the discussion by IOC Governing bodies of the mechanisms for coordination of GLOSS implementation and its monitoring, and on the present structure of this mechanism.

105 The discussion of this matter at the Twelfth and the Fourteenth Sessions of the IOC Assembly and the Nineteenth Session of the IOC Executive Council showed that although Member States recognized the need for coordination and monitoring of GLOSS implementation, different views were expressed regarding fixing the formal responsibilities within the IOC.

106 At present international coordination of GLOSS development is carried out by the IOC Secretariat in cooperation with some members of the Task Team on GLOSS through National Contacts for GLOSS designated by more than 60 Member States. The sessions of the Task Team are organized on ad hoc basis. Reports of the sessions of the Task Team were submitted to the IOC Technical Committee on Ocean Processes and Climate and the IOC governing bodies.

107 The Task Team agreed that the GLOSS development has reached such a stage of maturity that a more stable and permanent international body is required to ensure proper international coordination of GLOSS and to strengthen participation of Member States in GLOSS activities. By its nature, GLOSS is relevant to the Technical Committee on Ocean Processes and Climate, IGOS, IODE. It also relates to the activities of the IOC-WMO Intergovernmental TOGA Board, SSG for WOCE and other organizations: IHO, IAPSO, etc. At the Fourteenth Session of the IOC Assembly, GLOSS was noted as one of the most successful programmes of IOC with participation of more than 60 Member States.



108 The Task Team recommended that the IOC Executive Council at its Twenty-first Session approve the establishment of the permanent body on GLOSS for control and management of GLOSS implementation reporting either preferably directly to the IOC governing bodies or perhaps through appropriate subsidiary bodies of IOC. The Task Team proposed the following terms of reference for such body:

- (i) to develop the GLOSS system to include sea-level network, data flow and products;
- (ii) to up-date the GLOSS Implementation Plan at least every two years and formulate recommendations to the IOC governing bodies;
- (iii) to ensure proper liaison with other international research and ocean monitoring activities (such as TOGA, WOCE) and relevant bodies of IOC (Technical Committee on Ocean Processes and Climate, TC/IODE, regional bodies of IOC, ITSU, etc.); relevant joint bodies (Joint IOC-WMO TC/IGOSS, Joint SCOR-IOC CCCO, etc.); and other international organizations: IHO, UNEP and the IUGG;
- (iv) to provide advice and encouragement for the development of TEMA components of the GLOSS, including provision of instruments, their installation and maintenance, and training of specialists.

109 The Task Team then discussed financial resources needed for implementation of GLOSS which include provision of instruments, and their installations, regular training of specialists, meetings of experts, consultant missions, preparation and publication of technical and educational material.

110 The provision of instruments and their installation, that requires substantial financial expenditures, is mostly made by Member States themselves or with the help of other Member States on bilateral or multilateral basis.

111 However, in order to ensure proper functioning of the international activities which include expert meetings, expert missions, training courses and international publication, additional financial support is required. The Task Team recommended to call on Member States to explore the possibility of contributing to the IOC Trust Fund for GLOSS development.

#### 11. PREPARATION OF REVISED GLOSS IMPLEMENTATION PLAN

112 The IOC Assembly at its Fourteenth Session (March 1982), through Resolution XIV-2 requested that the Task Team review and up-date the GLOSS Implementation Plan (Doc. IOC/INF-663 rev.) circulated to Member States at the end of 1986. The revised Plan, as recommended by the IOC Executive Council at its Nineteenth Session (Resolution EC-XIX.6) will be published in the IOC Technical Series.

The Task Team reviewed the GLOSS Implementation Plan and suggested the following modifications and changes:

- (i) to add to the elements of GLOSS, a new element (V) a selected set of GLOSS tide gauge bench marks shall be accurately connected to a global geodetic reference system (i.e., the conventional terrestrial reference frame established by the International Earth Rotation Service (IERS)) (pages 1-2);
- (ii) in the Executive Summary include some basic requirements for GLOSS stations (accuracies, bench marks, desirability to measure additional atmospheric parameters (atmospheric pressure in particular)) (pages 1 and ii);
- (iii) up-date the Introduction in the light of developments since 1985;
- (iv) up-date and condense chapters on TOGA and WOCE (pages 8-11);
- (v) up-date list of GLOSS stations (include in the column country/territory) (jointly with K. Wyrtki and D. Pugh);
- (vi) to add brief description of new technology for sea-level measurements and transmission (page 29);
- (vii) paragraph 7.7 condense and combine with 3.3;
- (viii) paragraph 5.1 emphasize the importance of quality control of sea-level data by sea-level centres;
- (ix) page 37, up-date diagrams "GLOSS data flow";
- (x) pages 36-37, paragraphs 6.1 and 6.2 TOGA Sea-Level Centre and SOC for ISLPP (to be up-dated by Prof. Wyrtki);
- (xi) paragraph 6.3 "WOCE" to be up-dated by SSG for WOCE;
- (xii) paragraph 6.4 "FSMSL" to be up-dated by Dr. Pugh;
- (xiii) paragraph 6.5 page 39 to be up-dated;
- (xiv) paragraph 7 page 39 to be condensed;
- (xv) page 41 "Table" to be up-dated;
- (xvi) paragraphs 7.1 and 7.2 to be condensed;
- (xvii) paragraph 8 to be redrafted in the light of the discussion and decision of IOC;
- (xviii) reference to ISLPP for North and Tropical Atlantic should be made;

- (xix) references: pages 48-50: divided it into two categories: Reference and Bibliography (to include national guides and manuals on sea-level measurements, quality control, filtering, etc.) with the assistance of all participants in the Task Team;
- (xx) Annex II to be deleted;
- (xxi) Annex III to be up-dated and to add: GLOSS Contacts of Projects and Organizations (TOGA, WOCE, PSMSL, IOCARIBE, etc.);
- (xxii) Annex IV include description of only operational sea-level programmes;
- (xxiii) Annex VI to be deleted (included in the References);
- (xxiv) Annex VIII to be deleted (reference to PSMSL Catalogue);
- (xxv) Annex IX to be up-dated by Dr. Pugh;
- (xxvi) Annex X to be up-dated by Prof. Wyrcki.

114 The Task Team recommended that the Secretariat jointly with Prof. Wyrcki and Dr. Pugh finalize preparation of the GLOSS Implementation Plan by 1 April 1988 for submission for publication in the IOC Technical Series in 1988.

## 12. WORK PROGRAMME FOR 1988-1989

115 In order to encourage further participation of more countries and specialists in the GLOSS programme and to keep countries regularly informed on GLOSS implementation, the Task Team discussed the work programme on GLOSS implementation for 1988-1989. The work plan prepared by the Task Team is shown in Annex VI. The proposed actions are addressed to Member States (particularly with regard to installation and up-grading sea-level stations), to IOC governing bodies and the IOC Secretariat (with regard to expert consultation, training courses, expert missions, etc.).

116 The Task Team realized that most actions included in the Plan in order to implement GLOSS are not funded at present and therefore requested the Secretary to bring this plan to the attention of the IOC Executive Council in order to seek additional support and contribution for GLOSS implementation.

117 The Task Team, in particular, recommended that a popular Brochure on GLOSS be prepared in 1988 and the regular issue of GLOSS Newsletter be initiated by the Secretariat of IOC.

118 The Task Team also wished to encourage experts, involved in GLOSS, to write articles on GLOSS for inclusion in various scientific technical magazines.

119            The Task Team recommended that the Third Session of the Task Team be organized in mid-1989 at Bidston Observatory (PSMSL), and that provisional agenda of the session in addition to the review of implementation of all components of GLOSS, should include: relation of GLOSS to satellite altimetry and GLOSS stations in the Southern Ocean.

120            The Task Team also recommended to establish a logo for GLOSS and requested the participants to provide the Secretariat with their proposals so that the selection of GLOSS logo be made at the Third Session of the Task Team.

13.            ADOPTION OF THE SUMMARY REPORT

121            The Task Team reviewed and adopted the Summary Report with proposed changes and modifications.

14.            CLOSURE

122            The Chairman of the Task Team closed the meeting on the 23 October 1987.

ANNEX I

AGENDA

1. OPENING
2. ADMINISTRATIVE ARRANGEMENTS
3. GLOSS NETWORK STATUS AND DEVELOPMENT
4. REQUIREMENTS OF TOGA AND WOCE FOR SEA-LEVEL MEASUREMENTS
5. GLOSS DATA MANAGEMENT AND ACTIVITIES OF INTERNATIONAL SEA-LEVEL CENTRES
6. PREPARATION OF IGOSS SEA-LEVEL PILOT PROJECT (ISLPP) FOR THE NORTH ATLANTIC AND PROPOSALS FOR SIMILAR PROJECTS IN THE INDIAN OCEAN
7. REQUIREMENTS FOR ABSOLUTE GEODETIC LEVELLING OF SOME GLOSS STATIONS
8. IOC AND OTHER REGIONAL ACTIVITIES RELATED TO GLOSS
9. TEMA RELATED ACTIVITIES
10. INTERNATIONAL GLOSS CO-ORDINATION AND MANAGEMENT
11. PREPARATION OF REVISED GLOSS IMPLEMENTATION PLAN
12. WORK PROGRAMME FOR 1988-1989
13. ADOPTION OF THE SUMMARY REPORT
14. CLOSURE

ANNEX II

LIST OF PARTICIPANTS

I. MEMBERS OF THE TASK TEAM

Dr. A. Bolduc  
Department of Fisheries & Oceans  
200 Kent Street  
12th Floor, Centennial Towers  
OTTAWA  
ONTARIO K1A OE6  
Canada

Tel. 613/990.02.97  
Tlx. 534228  
Telemail: A.BOLDUC

Dr. W.E. Carter  
NOAA/N/SPD  
6001 Executive Boulevard  
ROCKVILLE  
MD 20852  
United States of America

Mr. Yang Dequan  
Deputy Director  
Data Processing Division  
National Oceanographic Data Centre  
P.O. Box 74  
TIANJIN  
People's Republic of China

Tel. 244161  
Tlx. 23138 NODC CN

Dr. C.S. Joshi  
Director, Geodetic & Research Branch  
and Convener, Geodetic VLBI Group  
Survey of India  
17 E.C. Road  
DEHRA DUN 248001  
India

Tel. (Off.) 24528  
(Res.) 24248  
Tlx. 0585210 DGRB IN

Prof. G.W. Lennon  
School of Earth Sciences  
Flinders University of South Australia  
BEDFORD PARK  
S.A. 5042

Tel. (08) 275.39.11 (08) 275.22.98 (08) 275.22.12  
Tlx. 89624 FLINDU AA  
Fax. (08) 275.2676

Dr. G.A. Maul  
US Department of Commerce  
National Oceanic & Atmospheric Administration  
Atlantic Oceanographic & Meteorological Laboratory  
MIAMI  
FLORIDA 33149  
United States of America

Dr. David T. Pugh  
Institute of Oceanographic Sciences  
Brook Road  
WORMLEY, Godalming  
SURREY GU8 5UB  
United Kingdom

(Chairman and Rapporteur)

Tel. Wormley (042879) 4141  
Tlx. 858833  
Telemail IOS.WORMLEY

Mr. S. Ragoonaden  
Meteorological Headquarters  
St. Paul Road  
VACOAS  
Mauritius

Tel. 861031  
Tlx. 4722 METEO IW

Dr. W. Scherer  
NOAA/National Ocean Service  
Office of Oceanography & Marine Assessment  
6001 Executive Boulevard  
ROCKVILLE  
MD 20852  
United States of America

Tel. (301) 443.82.56  
Tlx. RCA 248 376  
Telemail W.SCHERER

Mr. J.-M. Verstraete  
Institut Oceanographique  
195 rue St. Jacques  
75005 PARIS  
France

Tel. 43.25.63.10 - Ext. 14  
Telemail ORSTOM.PARIS

Prof. Klaus Wyrcki  
Department of Oceanography  
University of Hawaii at Manoa  
1000 Pope Road  
HONOLULU  
HAWAII 96822  
United States of America

Tel. (808) 948.76.33  
Tlx. 650-2478678  
Telemail K.WYRTKI

II. OBSERVERS

Mr. Patrick C. Caldwell  
TOGA Sea-Level Centre  
University of Hawaii at Manoa  
1000 Pope Road  
HONOLULU  
HAWAII 96822  
United States of America

Mr. Charles Ehler  
NOAA/National Ocean Service  
6001 Executive Boulevard  
ROCKVILLE  
MD 20852  
United States of America

Tlx. RCA 248376  
Telemail C.EHLER



Mr. Bernard J. Kilonsky  
Manager TOGA Sea-Level Centre  
University of Hawaii  
1000 Pope Road  
HONOLULU  
HAWAII 96822  
United States of America

Tel. (808) 948.65.74  
Telemail c/o K.WYRTKI

Dr. Gary T. Mitchum  
TOGA Sea-Level Centre  
University of Hawaii  
1000 Pope Road  
HONOLULU  
HAWAII 96822  
United States of America

Tel. (808) 948.61.61  
Telemail c/o K.WYRTKI

Mr. Richard J. Podgorny  
Chief, International Affairs Staff  
NOAA/National Ocean Service  
14th & Constitution Avenue, N.W.  
WASHINGTON  
D.C. 20230  
United States of America

Tel. (202) 377.80.47  
Tlx. RCA 248376  
Telemail R.PODGORNYY

Dr. Paul Wolff  
Assistant Administrator  
NOAA/National Ocean Service  
14th & Constitution Avenue, N.W.  
WASHINGTON  
D.C. 20230

Tel. (202) 377.46.99  
Tlx. RCA 248376  
Telemail P.WOLFF

III. SECRETARIAT

IOC      Dr. A. Tolkachev  
         Senior Technical Secretary  
         Intergovernmental Oceanographic Commission (IOC)  
         Unesco  
         1 rue Miollis  
         75015 PARIS  
         France

Tel. (1) 45.68.39.88  
Tlx. 204461F Paris  
Telemail IOC.SECRETARIAT

ANNEX III

PROPOSAL ON THE IGOSS SEA-LEVEL PILOT PROJECT  
FOR THE NORTH ATLANTIC (INA)  
(submitted by Dr. A. Bolduc)

1. BACKGROUND

The Global Sea-Level Observing System main objective is to have within five years an operational global network of permanent sea-level stations reporting monthly mean averages to the Permanent Service for Mean-Sea-Level (PSMSL). Analysis of the data products derived from this unique source of data will also demonstrate the important correlation of mean sea-level to climatic phenomena.

Since mid 1984, the University of Hawaii has been distributing a monthly anomaly sea-level map for the Pacific Ocean. The map (sample copy attached) shows the monthly deviation of the sea-level from the mean computed from the base period 1975-81. The deviation is illustrated by contours lines computed from some sixty tide gauges distributed all over the Pacific Ocean, including gauges located on islands. The project has been initiated by the Joint IOC/WMO WC for IGOSS building on the activities already implemented by Dr. Klaus Wyrski and has received support from all nations located around the Pacific Basin.

In light of the main objective stated in the GLOSS Plan (IOC/INF-663 rev.), it is now feasible to think of the production of the same kind of map for the North-Atlantic. It will assemble the mean sea-level data from this region into a product which can be useful for the Climate Programme. The Task Team on GLOSS has asked Canada to consider taking responsibility for the operation of A Specialized Oceanographic Centre for an IGOSS Sea-Level Pilot Project for the North-Atlantic (INA).

2. PROPOSAL

The Pilot Project will undertake to acquire on a monthly basis the monthly mean sea-level data at tide gauges located around and in the North-Atlantic Basin in order to obtain a monthly synoptic data set of mean sea-levels from which monthly Mean Sea-Level charts will be produced and disseminated. The data source will come from existing tide gauges identified suitable for such a project. Data from new tide gauges will also be incorporated into the INA network as soon as they become part of the GLOSS network and are suitable for the project. Various countries located around the basin will be asked to forward their mean sea-level data to Canada. This project will not interfere with the main objective of the GLOSS Plan as all the contributing countries will continue to forward their mean sea-level data to the Permanent Service for Mean Sea-Level (PSMSL), Bidston, UK, for archival in the usual fashion.

### 3. PROJECT GOALS

The Pilot Project is conceived as a test of the feasibility and usefulness of an operational Mean Sea-Level network for producing synoptic anomaly charts for the North-Atlantic. Although the ultimate goal could be an on-line data network with a variety of products, the pilot project will concentrate on assembling basic data from existing and future sources at 30-day intervals.

The INA project will have the following goals:

- (i) the identification and recruitment of tide gauges into an operation Mean Sea-Level network;
- (ii) the improvement of the data communication network for tidal and sea-level applications;
- (iii) the evaluation of the usefulness and the feasibility of producing synoptic Mean Sea-Level charts for the prediction of climatic trends, long-range weather, ocean processes and fisheries information;
- (iv) the improvement of the timeliness, quantity and quality of data flowing into the PSMSL archive.

The INA project hope to be successful in implementing an operational Monthly Mean Sea-Level anomaly chart for the North-Atlantic.

### 4. PROJECT DESCRIPTION

The basic component of INA will be the receiving, processing and quality control of the monthly mean sea-level data from the existing and future permanent gauging stations of Member States of the North-Atlantic Basin. Once received, the monthly mean sea-level data will be reduced and contoured in order to produce a monthly anomaly map for the North-Atlantic. As the GLOSS programme progresses, new stations will be added to the existing network in order to improve the data coverage and also to reduce uncertainties in the product.

The basic parameter required is the monthly mean sea-level. As there are many ways to compute such a parameter, Member States will be requested to indicate which of the following methods has been used to determine the data set from each gauging station:

- a) Arithmetic mean of hourly values;
- b) Low pass numerical filter of the hourly values;
- c) Arithmetic mean of paired high and low tidal levels.

The time periods used will be the regular calendar months.

Although it is recognized that atmospheric pressure is a major component of the sub-surface pressure, it will not be taken into account at least in the early stage of the project mainly because of the difficulty in obtaining such information. The inclusion of this parameter will be discussed in the final report that will be published at the end of the Pilot Project.

Most of the information from tide gauges will be acquired from existing material already available from the GLOSS programme, although particular information will be sought from Member States. Each existing gauge will be assessed for its usefulness in the Pilot Project. The use of mid-ocean mean sea-level is crucial to the success of the Pilot Project, however the number of islands is rather small for the North-Atlantic. Particular new locations should be earmarked for the installation of tide gauges under the GLOSS programme. Of course, this will be done in consultation and in co-operation with the various Member States concerned and the IOC Secretariat.

#### 5. PROJECT DEVELOPMENT

Because it is a pilot project for this area of the world, INA will come into effect in various phases. Along with their expected duration these phases will be:

Phase 1.: Define the probable network from the PSMSL archive and the List of GLOSS Sea-Level Stations (IOC/GLOSS-II/6) and identify the optimum gauge network for the pilot project. This phase should not be longer than three months and assistance from the IOC will be required to get the most up-to-date information and to arrange for the data to be submitted to Canada.

Phase 2.: Once the gauge network has been defined, the data communication will be tested. Monthly mean sea-level data from tide gauges will be received in various formats including mail, telephone, telex or electronic mail. MEDS will prepare a table of the data for each month and will distribute them to the various countries involved in the project for further dissemination in their own respective countries. This phase should not last more than six months.

Phase 3.: This phase will be concurrent to phase 2 and will require MEDS to prepare the base period for which mean level will be computed by month from the PSMSL archive. This base period will need to be similar for all tide gauges around the basin. This will permit the computation of sea-level anomalies from the monthly mean sea-level data derived from the tide gauge record. This phase will take two months to complete.

Phase 4.: With the assistance of the University of Hawaii, the computational procedure will be established and anomaly charts will be drawn using test data. This phase will also require a period of three months.

Phase 5.: If the tests are successful, synoptic anomaly maps will be produced from the data received each month from the various countries. This final phase should be extended over at least two years before the project can be evaluated in terms of its usefulness.

6. MANAGEMENT OF THE PROJECT

The management and the monitoring of the Project will be continuous and will be carried out by MEDS. The Project will be designed so that appropriate action can be undertaken to remedy problems in a timely fashion. The Project will be carried out under the auspices of IGOSS and the IOC Task Team of Experts on the Global Sea-Level Observing System (GLOSS). It will therefore report to the respective governing bodies of IOC.

ANNEX IV

REQUIREMENTS FOR ABSOLUTE GEODETIC LEVELLING OF SOME GLOSS STATIONS  
(submitted by Dr. B. Carter)

There is general agreement that tide gauge records indicate a global rise in relative sea level of about 10 to 15 cm during the past century. However the apparent rate of rise varies widely among gauges at least in part due to vertical land motions. On local and regional scales the land motion can be an order of magnitude larger than the estimated increase in sea level. If we are to refine our estimate of the rise in sea level and determine if that rate is increasing with time, we must cleanse the records of the effects of the vertical land motions, and create an absolute global sea level monitoring system. Recent advances in geodesy, most importantly the development of very long baseline interferometry (VLBI) and phase differenced Global Positioning System (GPS) techniques, for the first time make it possible to connect the tide gauges to a global geodetic reference frame with centimetre level accuracy. Improved absolute gravity meters capable of microgal repeatability (one microgal is equivalent to approximately 0.3 cm difference in height) may ultimately prove to be an even better method to monitor the vertical land motions. Comparison of VLBI, GPS, and absolute gravity measurements will enable geodesists to better estimate the accuracies of surveys. All tide gauges that are to be used to monitor global sea level must be connected to a local level network which is properly monumented and regularly re-surveyed (annually if possible). The level network should have a minimum of 6 to 10 bench marks and extend over a sufficient area to minimize the chances that local engineering projects or natural causes will destroy it. At least one of the marks should be located at a site suitable for GPS observations i.e. the horizon should be free of obstructions above 10 to 15 degrees elevation.

When possible tide gauges should be organized into regional networks, and GPS surveys should be conducted to determine their relative positions with an accuracy of 1 cm or better. These regional networks should be connected to the global VLBI reference frame at the earliest opportunity. During 1987 the National Oceanic and Atmospheric Administration (NOAA) initiated VLBI-GPS pilot surveys of tide gauges in Hawaii and along the U.S. Atlantic coast and Bermuda. Absolute gravity was measured in Bermuda and three sites are scheduled to be visited in Hawaii during October 1987. The purpose of these pilot surveys is to test and refine the field procedures, and ultimately to develop standards for tide gauge surveys. The results of these initial surveys will be presented by W.E. Carter and the participants of the meeting will be afforded an opportunity to ask questions and make suggestions for improving the second surveys, scheduled for 1988.

In addition to the high accuracy geodetic surveys directly connected to the tide gauges, geodesy can contribute to understanding changes in global sea level in a less direct but potentially equally

important manner. The long term global scale deformations of the Earth associated with glaciation-deglaciation must be accounted for in analyzing the tide gauge records. The most efficient method, and in the case of much of the historical records the only way of doing so, may be to use a model such as that developed by Peltier (1986). The Earth models and deformations assumed in such models infer rates of change of the length-of-day and secular motion of the rotation axis that must be consistent with those observed. The introduction of VLBI has improved both the accuracy and temporal resolution of Earth orientation measurements by more than an order of magnitude during the past few years, and these new measurements will place tighter constraints on the glacial rebound models. High priority should be given by the U.S. and Canadian geodetic communities to verifying the rebound patterns in the areas affected by the Laurentide ice sheet, and similarly by the European community to the area of the Fennoscandian ice sheet.

A much more detailed discussion of the contributions of geodesy to the monitoring of global sea level is presented in Carter et al. (1986).

#### References

Carter, W.E., Robertson, D.S., Pyle, T.E., and Diamante, J. The application of geodetic radio interferometric surveying to the monitoring of sea level, *Geophys. J.R. Astr. Soc.* 87, 3-13, 1987.

Peltier, W.R. Deglaciation induced vertical motion of the North American Continent, *J. Geophys. Res.* in press, 1986.



ANNEX V

NATIONAL OCEAN SERVICE'S NEW GENERATION WATER LEVEL MEASUREMENT SYSTEM  
(submitted by W.D. Scherer)

NGWLMS Field Unit Hardware

The NGWLMS production field unit is comprised of a primary measurement system made up of an air acoustic water level sensor, a primary data collection platform with satellite data telemetry, and a backup water level measurement system.

Primary Measurement System

The water level sensor for the primary measurement system is an air acoustic water level sensor, Aquatrak Model 3000, which is manufactured by Bartex, Inc., technique and is self-calibrating for variations in the velocity of sound. It has a measurement range up to 35 ft., with a resolution of  $\pm 0.01$  ft. The sensor sampling rate is nominally five per second and the average power consumption during operation is approximately 25 milliwatts. The Aquatrak requires a one half inch diameter sounding tube that will be installed inside a six inch diameter protective well that is equipped with a two inch diameter orifice. Where necessary, a parallel plate configuration will be installed to reduce measurement errors induced by high-current, and/or high-wave environments. The Aquatrak can be levelled directly to local benchmarks that provide absolute measurements referenced to local water level datums.

Power for the primary measurement system can be supplied from internal batteries, AC power, and solar cells. The typical NOS installation will use AC power to charge internal batteries. In the event of an AC power failure, the batteries will provide sufficient reserve to operate the system for up to 7 days. In installations where AC power is not available, the system will operate from external batteries with a solar cell for charging batteries. During normal operation, the system requires an average power of approximately 1 watt.

Primary Data Collection Platform

The primary data collection platform is a modular system based on the Sutron 9000 Remote Terminal Unit (RTU) and the 9000 RTU family of modules. The Central Processing Unit (CPU) is an 80C88 CMOS 16-bit micro-processor with EPROM, EEPROM and battery backed-up RAM memory. Programming is done in a high-level, PASCAL-like language called the SUTRON Data Language (SDL). SDL is a real-time multitasking language that provides an interface between data acquisition, control and communications.

The 9000 systems to be provided under this contract consist of the following modules: central processor, memory expansion, satellite communication, general purpose I-O, Aquatrak controller, telephone modem,

and power supply. The digital data acquisition capabilities include three 32-bit frequency counters, on 16-bit counter addressable through a multiplex input, and an RS-232 full duplex port. Analog acquisition is accomplished with a multiplexed 16-bit A-D converter that provides 12 differential voltage inputs with selectable voltage ranges over  $\pm 10$  volts.

Data acquisition and analysis are controlled by SDL application programmes that allow simultaneous sampling and averaging of sensor inputs and storage in the system database. The database is capable of storing up to 30 days of data from the primary water level sensor, backup water level sensor, and ancillary sensors typically consisting of wind-speed direction, air and water temperature, and barometric pressure.

Operator and user interface to the 9000 system is through either the RS-232 port or telephone modem. The modem is a Bell 212A compatible configuration and has capabilities for auto-dial and automatic baud rate detection. Access to the system is controlled through a multi-level password scheme that records each log in, restricts the actions available depending on passwords used, and limits the time allowed for each log in.

The primary means of data transmission from the field unit to NOS headquarters in Rockville is satellite altimetry via the GOES system. The 9000 RTU satellite module is a fully synthesized radio with capability for fixed or random transmissions. The field units will transmit acquired data every 3 hours, providing near real-time data for processing, dissemination, and field unit fault detection.

#### Backup Water Level Measurement Subsystem

A key element of the NGWLMS field hardware is a backup water level measurement subsystem that uses a pressure-type sensor and operates independently of the primary water level measurement subsystem described above. This approach provides a quality control check on measurements from the primary subsystem as well as a backup subsystem. The backup subsystem is an automated replacement for the bubbler tide gauge that is presently used as a backup system by NOS at most primary water level stations.

The backup subsystem is a Sutron Model 8200 programmable data logger with a Druck pressure sensor. The subsystem will sample and average water level measurements from the Druck sensor and store the information in battery backed-up RAM. Subsystem memory is adequate to store about 2 months of water level measurements.

The backup subsystem is operated from battery power only and can function unattended for over a year. Water level measurements collected by the backup subsystem are periodically transferred to the primary subsystem memory through an optically isolated RS-232 port for transmission over GOES, along with the primary water level data. In the event of a failure in the primary submission, the backup subsystem would continue to collect water level data that could be retrieved directly from the 8200 subsystem using a lap-top computer or equivalent.

### Summary

The National Ocean Service is developing a new water level acquisition, processing, analysis, and dissemination system that will employ state-of-the-art capabilities. In a phase-in mode, this new system will replace the existing system which is considered obsolete, difficult to maintain, and manual-labor intensive. The total system and its possible future applications are described.

Use of automated measurement processing at the gage, and the introduction of data quality assurance (DQA) parameters using system status checks, data statistics, and other information provided by the measurement systems will aid automation of data processing and analysis operations. Most existing measurement system-related errors and environmental sources of errors will be minimized through the use of noncontact sensors and new protective well design.

Improved and expanded products and services will be provided by the use of systems which are capable of operating in near real-time. Capability for automated archiving of data and dissemination of products will be established through computer network links supporting ocean and meteorological and oceanographic data will also be provided.

### 1. INTRODUCTION

The present water level measurement system uses essentially 1850's technology (stilling well, float, wire, pulley, staff) with a modified traffic counter (Analog to Digital Recorder (ADR)) which converts the water level data into digital format on punched paper tape. The present data processing system uses a variety of mini, micro, and mainframe computer technology, mostly obsolete, not electronically linked, subject to much downtime, and incapable of meeting requirements for real-time and near real-time operations. The present processing and analysis system (hard-ware and software) requires extensive human interface and interruption for manual operations.

Figure 1 shows some of the applications that the Sea and Lake Levels Branch (SLLB) has to satisfy. The uses of water level data range from hydrographic purposes, for making nautical charts, to climate research and long-term sea-level monitoring. One of the major legal uses for such data is the determination of marine boundaries, which requires a high degree of reliability with long-term measurements. The SLLB calculates the harmonic coefficients with which tide predictions are made. Data are also used for navigation, Great Lakes water level management, and specific uses such as tsunami and storm surge warnings. Long-term applications of these data include climate research and the global sea-level programme.

**Fig. 1 Sea and Lake Levels Programme Objectives**

**Provide for Collection, Analysis, Prediction and Dissemination of Sea and Lake Levels Data and Information for:**

- Hydrography
- Nautical Charting
- Circulation Surveys
- Marine Boundary Determinations
- Tide Predictions
- Navigation
- Great Lakes Water Management
- Tsunami Warnings
- Monitoring Long-Term Sea-Level Trends
- Coastal Construction
- Oceanographic Research
- Climate Research

This paper will be divided into four parts. The first part will give a clear statement of the problem. The second part will describe the old, i.e., the present solution at NOS. The third part will provide a description of the new solution, and the fourth part will provide a glimpse into the future and the various applications.

**2. STATEMENT OF THE PROBLEM**

The statement of the problem is found in Fig. 2, taken from Kinsman (1965), which is, as he says, a schematic and fanciful representation of the wave power spectrum. The kind of information to be extracted is at the low end of the spectrum, i.e., the tidal information. The rest of the spectrum is due to other energies that come from wind and waves and is unwanted in the data. The solution must be carefully developed using a technique that rejects all the rest of that information without introducing aliasing or biasing errors.

QUALITATIVE WAVE POWER SPECTRUM

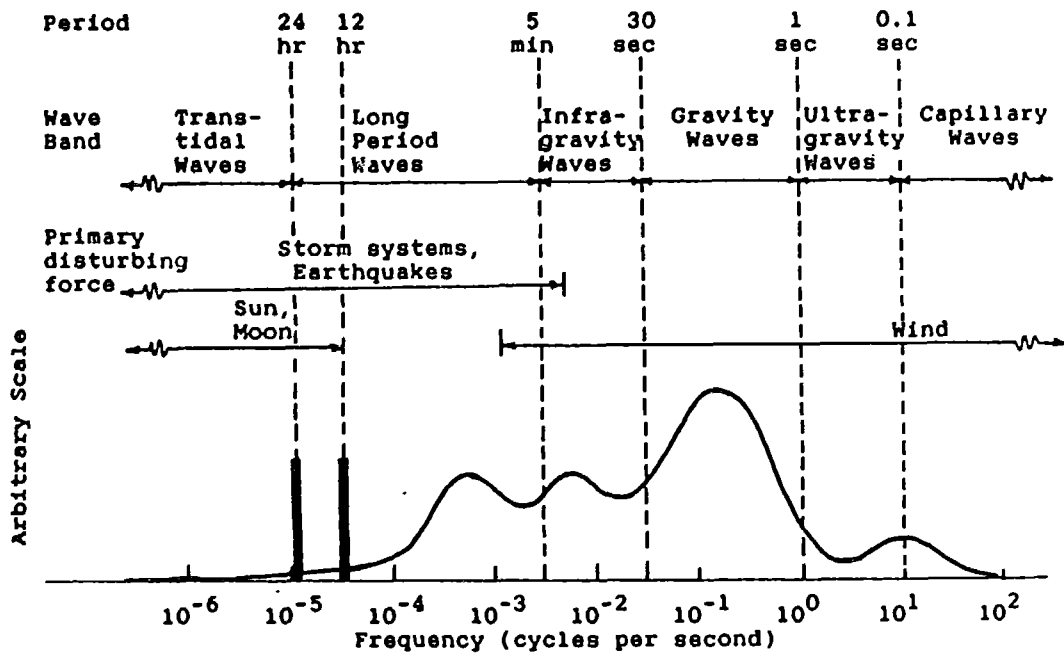

Ref: Kinsman, Blair, Wind Waves: Their Generation and Propagation on the Ocean surface. Prentice-Hall, Inc., Englewood Cliffs, New Jersey, 1965, p. 23.

Fig. 2 Schematic (and fanciful) representation of the energy contained in the surface waves of the ocean-in fact, a guess at the power spectrum

3. PRESENT NOS WATER LEVEL MEASUREMENT SYSTEM

The existing system is composed of several different types of measurement and recording systems, several different data processing systems, and associated computer software as outlined in the schematic sketch in Fig. 3. The present water level measurement programme capability is largely characterized by mechanical systems requiring constant tending and maintenance, punched-paper tape recording, data transmission by monthly mail, hardware/software incompatibilities between systems, and significant human interaction during data processing and analysis. The equipment and facilities are obsolete and are not capable of satisfying current and future NOS and other user needs for better data quality, multiple methods of near real-time data transmission, and for obtaining additional oceanographic and meteorological data.

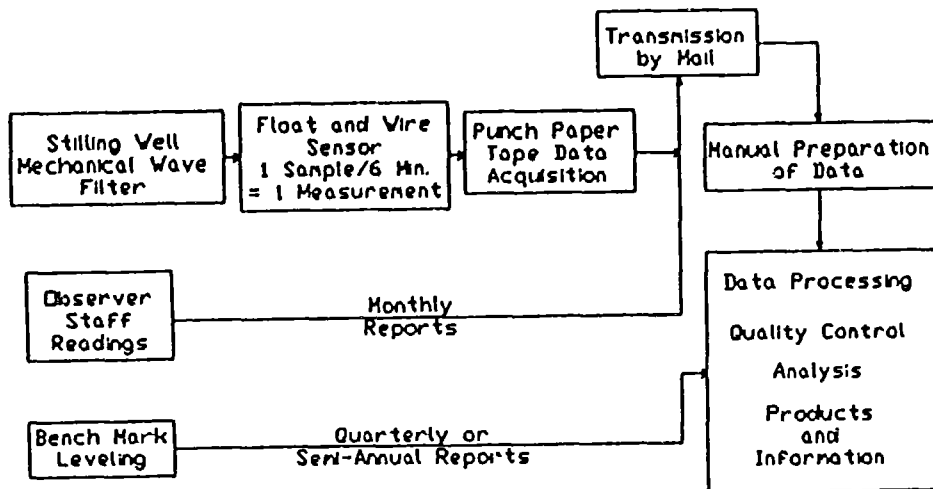

Fig. 3 Present water level measurement system

Figure 4 shows the typical tide station installation at the coastline, including the stilling well, which extends into the water with the float and wire device, a staff, and an observer who tries to ensure that everything is functioning properly.

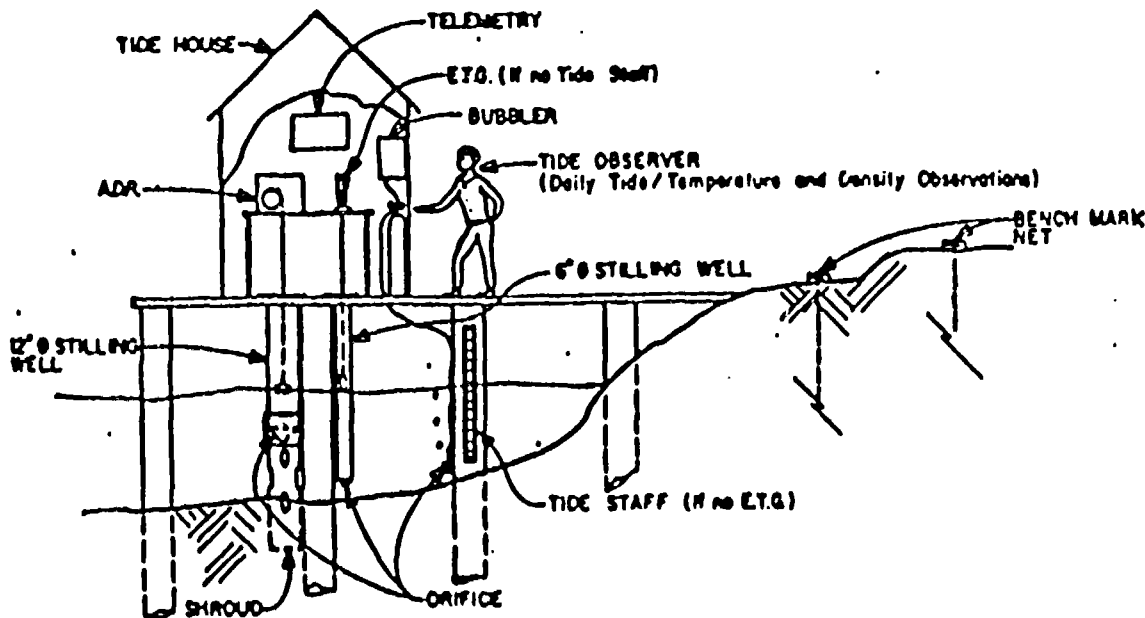

Fig. 4 Typical NOS Primary Tide Station Installation at the Coastline, including stilling well

The present system depends on an ADR attached by a stainless steel wire to a float in a stilling well. It is intended to filter out all high frequency energy contained in sea surface waves, while leaving very long period waves, weather perturbations and the tidal periods.

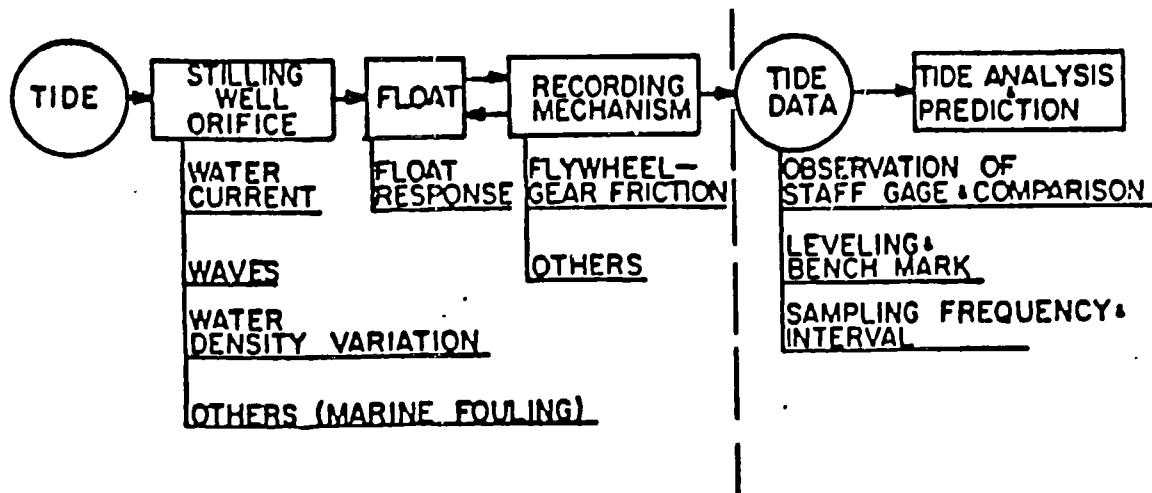

Fig. 5 Schematic diagram of the error sources in ADR tide measurement system

The measurement subsystem is schematically depicted in Fig. 5 and depicts the major components now in use including the major potential error sources in each of these components. An input force has to go through a stilling well, float device, and recording mechanism. The most critical problem is the stilling well, which is a nonlinear mechanical filter, and, thus, has various problems associated with it. Errors can be introduced due to currents, waves, and water density variations, i.e., the trapping of water of one density inside the well that is not the same density as the water outside (when the gage is in an estuary). There can also be marine fouling problems, which are the worst kind of problem in some of the locations. Growth can occur inside the well. This growth can collapse and fall down on the orifice causing water to come in but not get out, or it can restrict the opening which changes the filter characteristics of the well and dampen out the tide signal. The float response also has some problems, because it is a mechanical device. One has the typical problems associated with mechanical devices that are put into a marine environment.

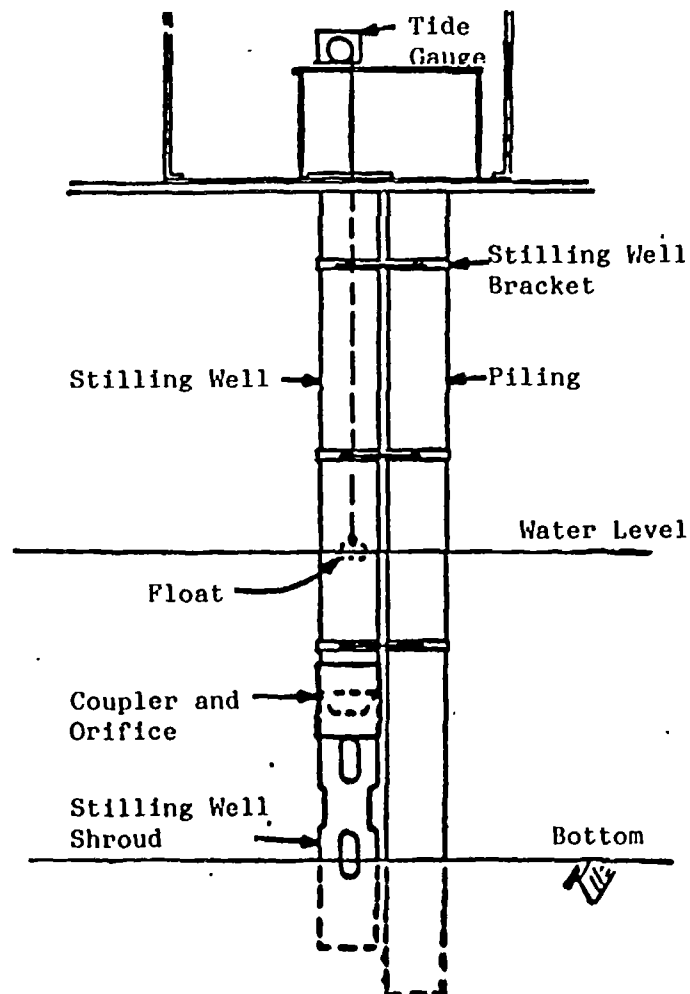

Fig. 6 Float operated tide gauge

The stilling well is shown schematically in Fig. 6. A typical primary station installation has a 12-inch diameter well with an opening in the bottom that is 1-inch in diameter. Some of the old installations have a shroud with lateral holes and slots to protect against some of the "pull-down" problems. This problem arises due to the current or wave-generated flow across an orifice, which causes a Bernoulli effect and results in a water level draw down. Instead of having an average water level commensurate with the outside, one ends up with a biased low reading (Fig. 7a).



The density effect is illustrated in Fig. 7b. Water at one density can be trapped inside the stilling well, followed by the occurrence of a salt wedge or fresh water runoff. This causes different densities inside and out. The float will ride on what is inside. This can cause bias problems, the worst kind of problem that one can have.

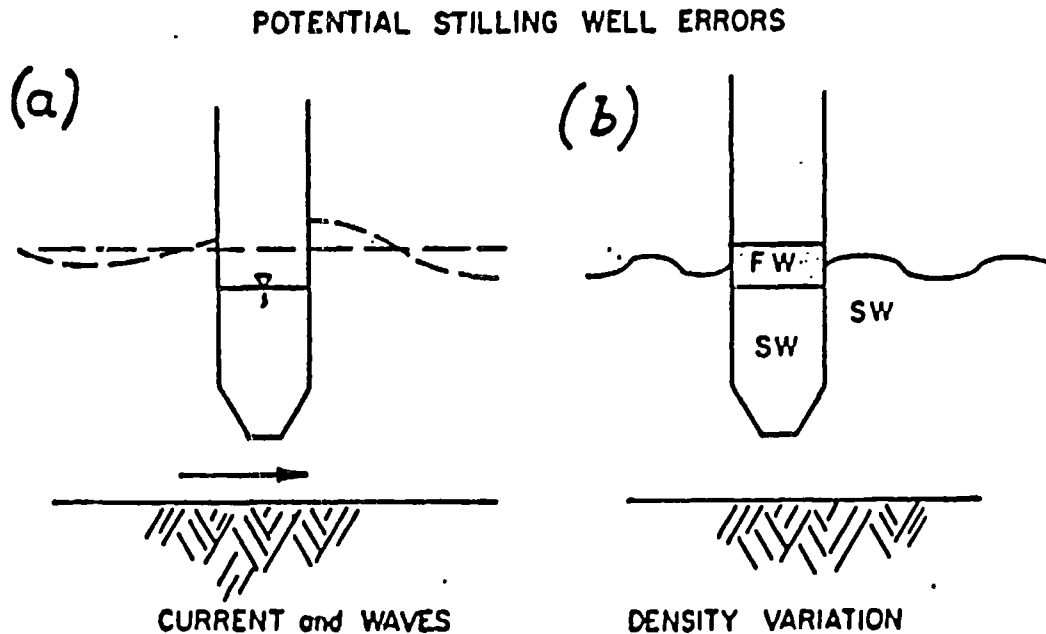

Fig. 7 Potential errors of present stilling well

The ADR water level gauge collects one instantaneous sample each 6 minutes. This single sample has large error bars and is susceptible to the aliasing problems mentioned earlier. Connection between the ADR gauge and the tide staff is made by an observer who records daily staff and gauge readings. The observer probably introduces the largest uncertainty into the error budget of the water level measurements.

Stations of the National Water Level Observation Network typically contain 10 or more bench marks which are levelled to each other and the tide staff semiannually. The nominal accuracy of these levellings (2nd order, Class I), between two bench marks is typically 1 mm (.004 ft).

At the beginning of each month, the previous month's water level record (punched paper tape) is taken off the ADR and mailed with the observer's staff readings, to the central processing facilities in Rockville, Maryland. The observer's staff-to-gauge readings are analyzed by hand, the water level record is read into the computer. The two are combined and considerable error checking is performed to produce a preliminary monthly data record. For tidal water levels, these data are then analyzed, additional error checking is performed, comparisons with other nearby tide stations are run and levels are checked for stability. Finally, tidal data, bench mark elevations and other derived data products are produced.

One of the greatest values of NOS data sets is the length of the records collected. An example is provided in Fig. 8. This tide station at San Francisco has been operating for 131 years. The solid line represents a running boxcar average. Many of the events reflected in this diagram may be explained in terms of El Nino events.

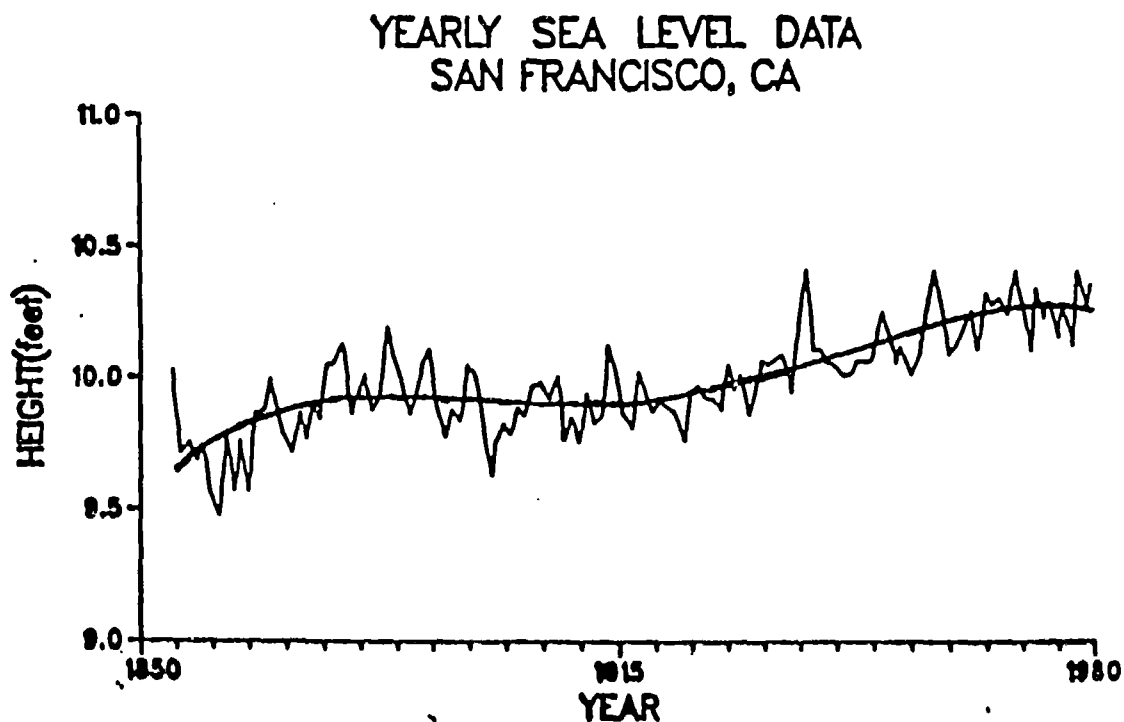

Fig. 8 Yearly Sea-Level Data San Francisco, CA

4. PROPOSED NEW SYSTEM

The Next Generation Water Level Measurement System (NGWLMS) is designed to address and correct the problems inherent in the sea and lake levels measurements and analysis programme (Fig. 9). To solve the nonlinearity, aliasing and biasing problems with the stilling well, NOS is shifting to a protective well setup. Only waves of periods shorter than 2-3 seconds will be screened out. Because of the higher frequencies present in this new setup a much higher rate of sampling is required. A self calibrating acoustic sensor that will take 181 samples in 3 minutes centered at 6 minute intervals will be used. In computing the average for a 6-minute water level measurement a number of data quality assurance parameters will be calculated. Three standard deviation values will be calculated for the purpose of rejecting outliers. The number of outliers will be retained as one piece of the information. The recomputed average measurement, the standard deviation, and all DQA parameters are stored each 6 minutes. It is indeed possible, with today's microprocessors, to go into higher order statistical moments and insert those into the data stream and send them home. This is a possibility for the future. This multiple sampling should greatly increase the reliability of each 6-minute measured values. The acoustic sensor will be levelled in directly, thus obviating the need for an observer.

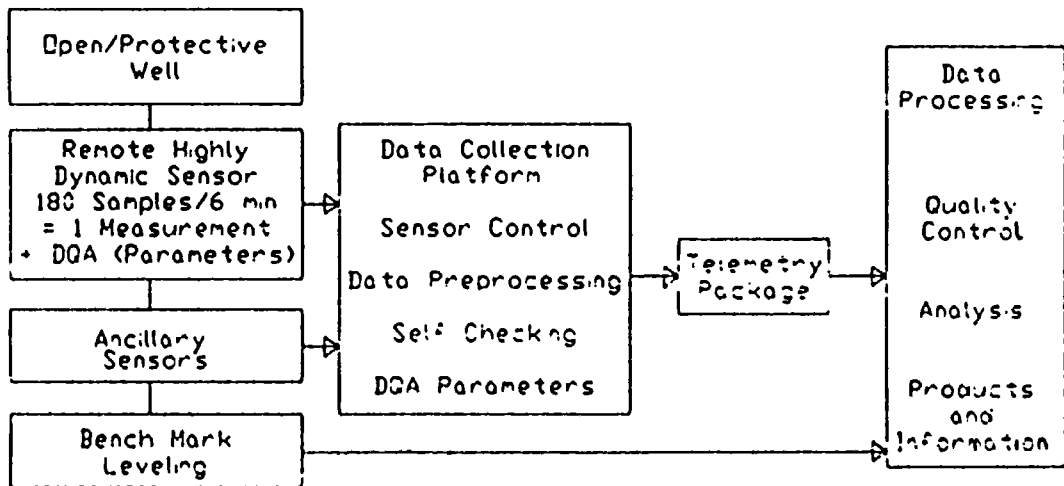

Fig. 9 Next Generation Water Level Measurement System  
Block Diagram

Water level data will be stored on a data collection platform (DCP). This DCP can also accommodate additional sensors. These may include a backup water level sensor, air temperature, water temperature, water density, conductivity, current speed, current direction, wind speed, wind direction, barometric pressure and rainfall. Up to 11 sensors may operate through the NGWLMS DCP. Data from these sensors will be stored at the DCP for up to 15 days. Communication between the DCP and the Rockville, Maryland, facility will be through the Geostationary Operational Environmental Satellite (GOES) with telephone as a backup. The system will also allow line-of-sight radio communication for local applications such as dredging operations or support of hydrography. Fig. 10 illustrates the NGWLMS communication options.

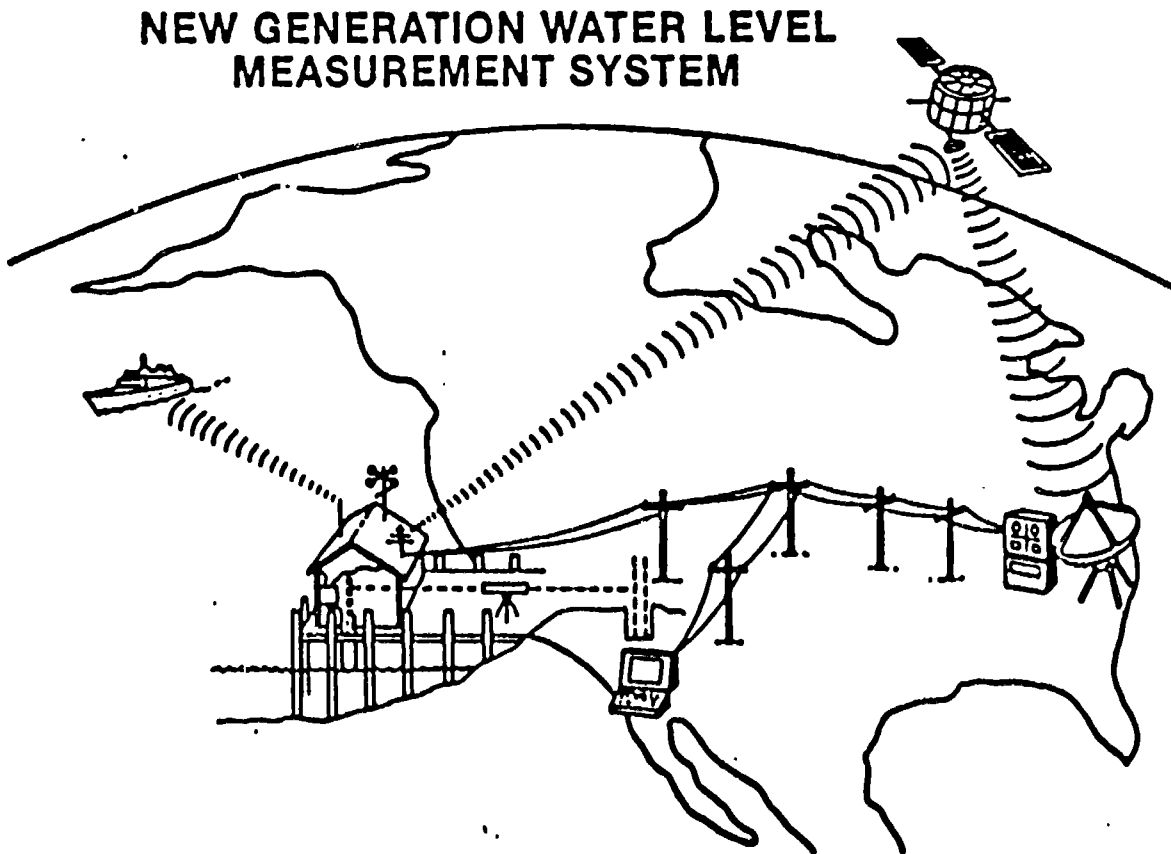

Fig. 10. New Generation Water Level Measurement System communication options

Levelling reports and generalized station information will be entered into a portable personal computer (PC) and can be transmitted via telephone directly into the planned computer facility in Rockville, Maryland. The data collected by the DCP will be transmitted every 3 hours via satellite. Approved outside users will be able to access the raw data real-time by telephone or line-of-sight radio and near real-time via a tap of the satellite communication. Once the data are received at the central computer facility the data will be automatically reprocessed and entered into the NOS database system. Many sensor or DCP problems should be detected and troubleshooting initiated within a few hours of receipt of data. SLLB analysts will review the collected data, and data quality assurance procedures will be performed.

All information will reside in the NOS database system. For many users, SLLB information specialists will be able to compile and disseminate near real-time and historical information in a timely and cost-effective manner. More sophisticated users will be allowed access to the system directly with automatic transfer of large amounts of data.

5. APPLICATIONS

Present applications for the NGWLMS include the Columbia River real-time water level system. This system was implemented with the Corps of Engineers for dredging purposes. An other application is in New York Harbour where NOS has acted as technical consultant for New York State and put together a system in the harbour consisting of four water level stations located at Sandy Hook and Bergen Point, New Jersey, and the Battery and Willetts Point, New York. All the data come in via dedicated telephone line to a central collection site in downtown Manhattan where they are collected and then disbursed to users, i.e., subscribers of the system.

GLOBAL SEA LEVEL NETWORK: • existing • planned stations

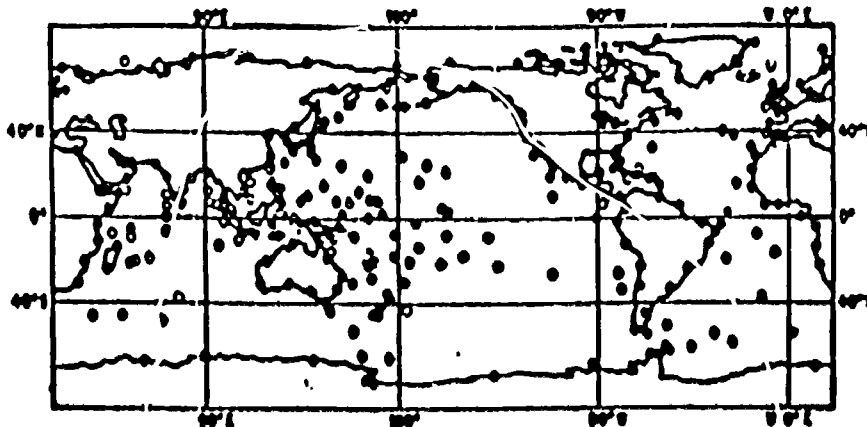

Fig. 11 Planned global sea-level monitoring programme

For applications further into the future, NOS is working with the Office of Atmospheric Research (OAR), who has prepared an initiative to start a global sea-level monitoring programme (Fig. 11). The network consists of roughly 200-250 stations distributed around the globe. The black dots are existing stations, all of which consist of present technology, not the new generation type of system; they need to be updated. Additional stations for more complete global coverage are established. NOS is working with OAR to develop a truly international programme. The hope is to get this programme going by 1989, using the new generation type of system, linked up with global positioning system as shown in Figures 12 and 13 in order to obtain absolute measurements of water level.

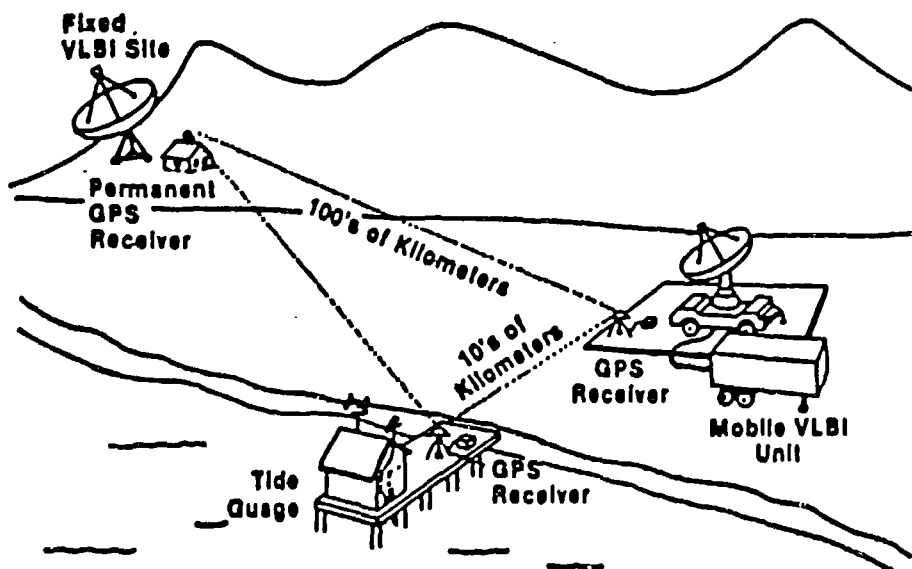

Fig. 12 Proposed link of tide gauges and geodetic controls

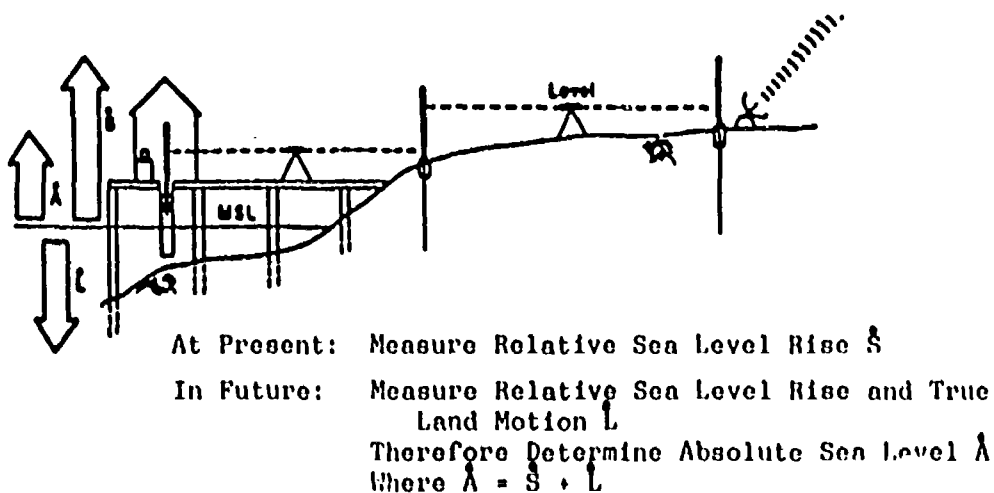

Fig. 13 Proposed technique for measuring absolute sea-level

OMA's List of the First Fifty Water Level Stations  
Recommended to receive NGWLMS  
(Global Sea-Level Observing System (GLOSS))

Tide Station Locations

3. Boston, MA
6. Montauk, NY
8. Atlantic City, NJ
10. Ocean City, MD
11. CBET, VA
12. Duck Pier, NC
13. Myrtle Beach, SC
15. Fort Pulaski, GA
16. St. Augustine, FL
17. North Miami Beach, FL
18. Key West, FL
20. Clearwater Beach, FL
22. Pensacola, FL
26. Corpus Christi, TX
27. Maqueyes Is., PR
28. San Juan, PR
29. Bermuda
30. La Jolla, CA
32. Port San Luis, CA
34. San Francisco, CA
35. Crescent City, CA
38. Neah Bay, WA
40. Sitka, AK
41. Seward, AK
42. Unalaska, AK
45. Honolulu, HI
46. Midway
47. Guam
48. Wake Is.
49. Pago Pago
50. Truk

PROPOSED WORK PROGRAMME  
FOR THE GLOSS IMPLEMENTATION  
1987-1988-1989

PROPOSED ACTIONS	1987	1988	1989
1. Submission of the Recommendations of the Second Session of the IOC Task Team of Experts on GLOSS to the Twenty-first Session of the IOC Executive Council		7-15 March Paris	
2. Consideration of GLOSS development in support of TOGA at the First Session of the IOC-WMO Intergovernmental TOGA Board	2-6 November Geneva, Switzerland		
3. Preparation and publication of the GLOSS Implementation Plan (IOC Technical series)		First half	
4. Assistance in installation and up-grading GLOSS sea-level stations (according to the Appendix)			
5. Sea-level observations within the framework of GLOSS in hostile conditions:			
5.1 Expert Consultation on Sea-Level Measurements in Hostile Conditions (polar regions) (GLOSS/WOCE)		26-31 March Bidston, U.K.	
5.2 Scientific Seminar/Workshop on Sea-Level Measurements in Hostile Conditions			15-19 April Bidston, U.K.
5.3 Consideration of GLOSS sea-level stations in the Southern Ocean at the Third Session of the IOC Task Team			Mid 1989
6. Liaison and encouragement of GLOSS implementation with the IOC Regional Bodies (regional components of GLOSS):			
6.1 IOC/INDIO-I	3-11 December Arusha, Tanzania		
6.2 IOC/INDIO-II		April Islamabad, Pakistan	
6.3 WESTPAC-V			September China
6.4 El Niño		November Chile	
6.5 IOC/ARIBE-III			First half Caracas, Venezuela

ANNEX VI

IOC/GLOSS-II/3  
Annex VI



PROPOSED ACTIONS	1987	1988	1989
7. Presentation of the Report on GLOSS Implementation to:			
7.1 Third Session of the IOC Technical Committee on Ocean Processes and Climate			March Paris
7.2 Fifteenth Session of the IOC Assembly			March, Paris
8. Third Session of the IOC Task Team of Experts on GLOSS			Mid 1989 Bidston (PSMSL) U.K.
9. Preparation and publication by IOC of a popular brochure on GLOSS		April	
10. Regular publication by IOC of a GLOSS Newsletter (as part of the IOC Newsletter on Ocean Observing System), twice a year		.	.
11. Preparation by scientists, participating in GLOSS articles on GLOSS, articles on GLOSS for various scientific magazines		.	.
12. Monitoring of submission of sea-level data to the international sea-level centres (PSMSL, SOC for ISLPP in the Pacific Ocean, TOGA Sea-Level Centre; SOC for ISLPP in the North Atlantic)		January/July	January/July
13. Approval and Implementation of the IGOSS Sea-Level Pilot Project in the North Atlantic			
13.1 Preparation of a Draft Plan for ISLPP in the North Atlantic (in consultation with the Technical Committee for IGOSS)		February/March	
13.2 Approval of the ISLPP by the IOC		March 1988	
13.3 Initiate Pilot Project		Mid 1988	.
14. Submission of the GLOSS Implementation Plan to the International WOCE Scientific Conference		October, Paris	
15. Consider jointly with SSG for WOCE needs and requirements for the establishment of the Sea-Level Centres for WOCE and assist and advise on their establishments		.	
16. Arrange and support sea-level training courses			
16.1 By Bidston Observatory (PSMSL), U.K.	June-July	June-July	June-July
16.2 By EPSNOM (France) in Brest for french speaking countries)			

PROPOSED ACTIONS	1987	1988	1989
16.3 Consideration of other offers for sea-level training courses (by Portugal, People's Republic of China, Thailand, Australia) at IOC Executive Council		March, Paris	
17. Methods for sea-level data filtering			
17.1 Preparation of Bibliography of methods used in different countries			
17.2 Compilation of methods used for sea-level data filtering for submission to the Third Session of the IOC Task Team			Mid 1989 Bidston, U.K.
18. Relation of GLOSS to satellite altimetry - Consideration of possible incorporation of satellite altimetry data into GLOSS at the Third Session of the IOC Task Team			Mid 1989
19. Expert Consultation on the assistance in setting up GLOSS stations in the IOCEA area (experts from France, Federal Republic of Germany, Portugal, Sweden, Chairman of IOCEA)		Mid 1988	

Appendix 1

GLOSS STATIONS FOR WHICH ASSISTANCE IS REQUIRED IN THEIR INSTALLATION OR UP-GRADING  
FROM IOC MEMBER STATES IN 1988-1989

Ocean	IOC region	Country	GLOSS station		Country which will assist or need assistance	Country which might or is requested to assist	Remarks				
			Location	GLOSS No.							
INDIAN	IOCINCEO	SOMALIA *	Mogadishu	7	USA	China	under installation A tide gauge from China was offered through IOC				
			Hafun	6							
		MADAGASCAR *	Fort Daupain	271	USA		Portugal	Assistance needed to install a tide gauge available			
			MAURETIUS *	Agalega					276		
		SEYCHELLES *	Aldabra	14	USA		Portugal	Tide gauge has been provided will be installed soon			
		MOZAMBIQUE *	Pemba Inhambane	21 10							
		IOCINDIO	OMAN *	Salalah	4		USA	USA/China	Portuguese experts visited sea-level stations in 1986		
			P.D.R. YEMEN *	Aden	3		USA				
			INDIA	Minicoy	29		USA/Australia			USA/China	Automated stations are required
				Port Blair	38						
	BANGLADESH		Chittangong	36	USA/Australia	USA/China	Tide gauge from China was offered through IOC				
	SRI LANKA *	Port of Colombo	33								
	PACIFIC	WESTPAC	BURMA	Akyab	37	USA/Australia	USA/China	Tide gauge from China was offered through IOC			
				Moulmein	141						
			INDONESIA *	Ambon	68						
PACIFIC	WESTPAC	INDONESIA *	Kupang	50	USA/Australia	USA/China	Tide gauge from China was offered through IOC				
			Manado (Bitung)	69							
			Sorong	67							
		VIET NAM *	Qui Nhon	75							

\* Countries which expressed their needs for assistance.

Ocean	IOC region	Country	GLOSS station		Country which will assist or need assistance	Country which might or is requested to assist	Remarks
			Location	GLOSS No.			
ATLANTIC	IOCEA	GIANA *	Tema	258	Portugal	Sweden, Federal Republic of Germany, Portugal, France	Those countries have been requested by the Task Team to assist the countries of the IOCEA region
		NIGERIA *	Lagos	259			
		SIERRA LEONE *	Aberdeen Point	256			
		SENEGAL *	Dakar	253			
		CAPE VERDE *	Porto Grande	254			
		ANGOLA *	Lobito	262			
		SAO TOME AND PRINCIPLE *	Sao Tome	260			
		BRAZIL	Porto de Natal	197			
			Fernando de Noronha	198			
			Tenedo Sao. Pedro - Sao Paulo	199			
	TOCARIFE	MEXICO	Progreso	213	USA Venezuela	To be coordinated with the IOCARIBE Secretariat and countries of the region	
			Veracruz	212			
			Trinidad and Tobago	Port of Spain			203
			HAITI	Port-au-Prince			209
			CUBA *	Ginera			276
	Siboney	215					
	Cabo San Antonio	214					
	JAMAICA *	Kingston	210				

\* Countries which expressed their needs for assistance.

ANNEX VII

PRESENT STRUCTURE FOR CO-ORDINATION  
OF THE GLOSS IMPLEMENTATION AND MONITORING

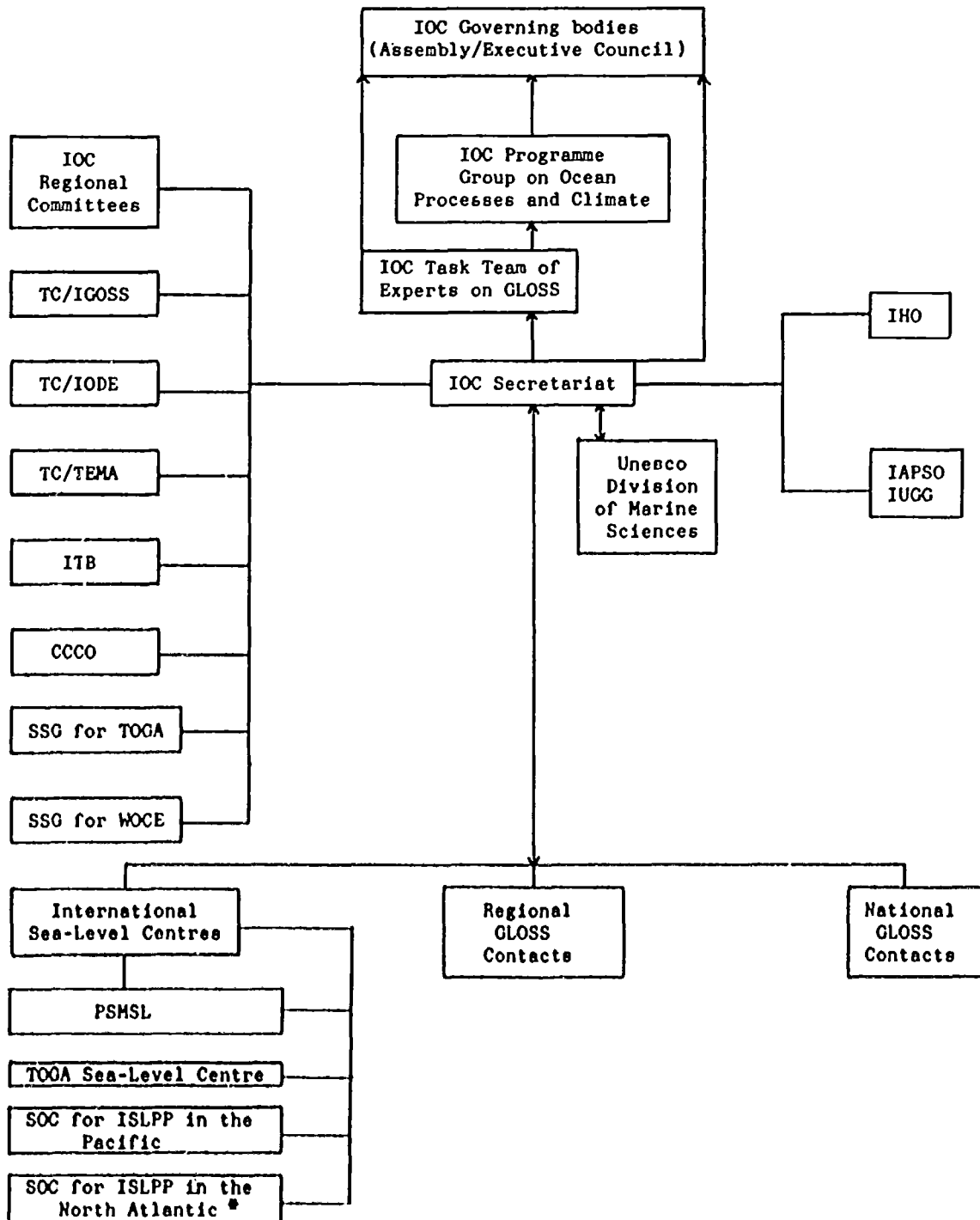

\* It will start its activities in 1988.

SEA-LEVEL TRAINING COURSES

N N	Date	Place	Participants		
			Country	Names	Address
1.	12-30 September 1983	Bidston Observatory, IOS, UK	Kenya	Mr. M.O. Odido	Kenya Marine & Fisheries Research Institute, Mombasa Laboratory, P.O. Box 81651, Mombasa (Telex: 21115)
			Mauritius	Mr. S. Ragoonaden	Meteorological Services Headquarters, St. Paul Road, Vaohas (Phone: 861031 - Telex: 4722 METEO)
2.	25 June-13 July 1984	Bidston Observatory, IOS, UK	Tanzania	Mr. A.T. Shannugan	Tanzania Harbours Authority, Dar-es-Salaam
			Madagascar	Mr. R.M.L. Ranaivonon	Malagasy Ministère de l'Enseignement Supérieur et de la Recherche Scienti- fique, Centre National de Recherches Océanographiques (CNRO) de Nosy-Be, B.P. 68, Nosy-Be (Phone: 613-73)
			Mauritius	Mr. Sooramania	Meteorological Services Headquarters, St. Paul Road, Vaohas (Phone: 861031 - Telex: 4722 METEO)
			China, People's Rep. of	Mr. Zhao Xueai Mr. Wang Ji	Institute of Marine Scientific & Tech- nological Information, National Bureau of Oceanography, Tianjin, P.O. Box 75, 118 Qiwei Road, Hedong District, Tianjin

ANNEX VIII

IOC/GLOSS-11/3  
Annex VIII

X X	Date	Place	Participants		
			Country	Names	Address
3.	23 August- 27 September 1984	National Bureau of Oceanography, Tianjin, China (jointly with Unesco D.OS.)	Pakistan	Mr. Arshad Ali	National Institute of Oceanography, 37-K/6, P.F.C.H.S., Karachi 29 (Phone: 434308)
			Bangladesh	Mr. Ali Ahmed	Bangladesh Meteorological Department, Climate Division, Azargaon, Dhaka-7 (Phone: 327814)
			Sri Lanka	Mr. P.V. Wijayaratna	Department of Coast Conservation, Maligawatte Secretariat, Colombo 10
			Malaysia	Mr. Chongyan Lee	School of Physics, Universiti Sains Malaysia, Penang (Phone: 04-883822 Ext. 675)
			Papua New Guinea	Mr. Pekou Chakumai	Dept. of Transport & Civil Aviation, Hydrographic Section, Marine Division, P.O. Box 457, Konedobu (Phone: 211866 Ext. 345)
			Philippines	Ms. Nena R. Okan	Bureau of Coast & Geodetic Survey, 421 Barraca Street, San Nicolas, Manila (Phone: 47-96-11)

N N	Date	Place	Participants		
			Country	Names	Address
3.	23 August- 27 September 1984 (Cont'd)	National Bureau of Oceanography, Tianjin, China (jointly with Unesco D.OS.)	Democratic People's Republic of Korea	Mr. Kang Gil U	Oceanographic Research Institute of the Korean West Sea, Nampor City
			Kuwait	Mr. Abdullah Al-Salem	Kuwait Institute for Scientific Research, P.O. Box 24885, Safat (Home Phone: 813895)
			Arab Republic of Egypt	Mr. Tarek Helmy Mohamed Omran	Suez Canal Authority, Research Center, Ismailia (Home Phone: 726302 Cairo)
			Algeria	Mr. Mejdoub Benzohra	Institut des Sciences de la Mer & de l'Aménagement du Littoral, Jetée Nord- Alger, B.P. 90, Alger-Bourse (Phone: 62-73-19)
			Guinea, West Africa	Mr. Toumany Camara	Centre de Recherche Scientifique de Conakry-Rogbane, B.P. 561, Rogbane Conakry
		Sudan	Mr. Ibrahim Elsayed Elbeshir	Institute of Oceanography, National Council for Research, P.O. Box 2404, Khartoum (Phone: 2509)	



N N	Date	Place	Participants		
			Country	Names	Address
4.	24 June- 12 July 1985	Bidston Observatory, IOS, UK	Colombia	Dr. Margarita Astralaga	Centro de Investigaciones Oceanograficas e Hidrograficas, Asesora, Division Ambiental del Instituto Nacional de Proteccion Recursos Naturales, Bogota (Telex: 45413 MRRE CO - Ministerio de Relaciones Exteriores)
			Ecuador	Mr. Julio Falconeri Rosero Pincay	Instituto Oceanografico de la Armada, Casilla No. 5940, Guayaquil (Phone: 431105 or 431300 - Cable: INOCAR GUAYAQUIL)
			Peru	Dr. Francisco Vasquez Pita	Instituto del Mar Peruano (Delegacion Permanente del Peru ante la Unesco)
			Chile	Mr. Ariel Eduardo Vera	Instituto Hidrografico de la Armada, Errazuri 232 Playa Ancha, Casilla 324, Valparaiso (Phone: 251056 or 251061 - Telex: 230362 HIDRO CL)

N W	Date	Place	Participants		
			Country	Name	Address
5.	23 June-11 July 1986	Bidston Observatory, IOS, UK (4th Training Course)	Indonesia	Mr. Rochman Djaja	National Co-ordination Agency for Surveys & Mapping, Bakosurtanal, Jakarta
			Nigeria	Dr. Chidi Ibe	Institute for Oceanography & Marine Research, Lagos
			Sierra Leone	Mr. Charles Mustapha	Institute of Marine Biology and Oceanography, Freetown
			Seychelles, Rep. of	Mr. Gaetan Sauzier	Directorate of Civil Aviation Seychelles International Airport
6.	22 June-10 July 1987	Bidston Observatory, Proudman Oceanographic Laboratory, UK (5th Training Course)	Pakistan	Mr. Asif Lakhani	National Institute of Oceanography 37-K, Block 6, P.E.C.H.S., Karachi 29 (Phone: 440460 - Telex: 24681 NIO)
			Somalia	Mr. Yusuf Ismail Araleh	Somali Port Authority, Mogadishu
			Sri Lanka	Dr. W. Shanti Wickremeratne	National Aquatic Resources Authority (NARA), Crow Island, Mattakkuliya, Colombo 15

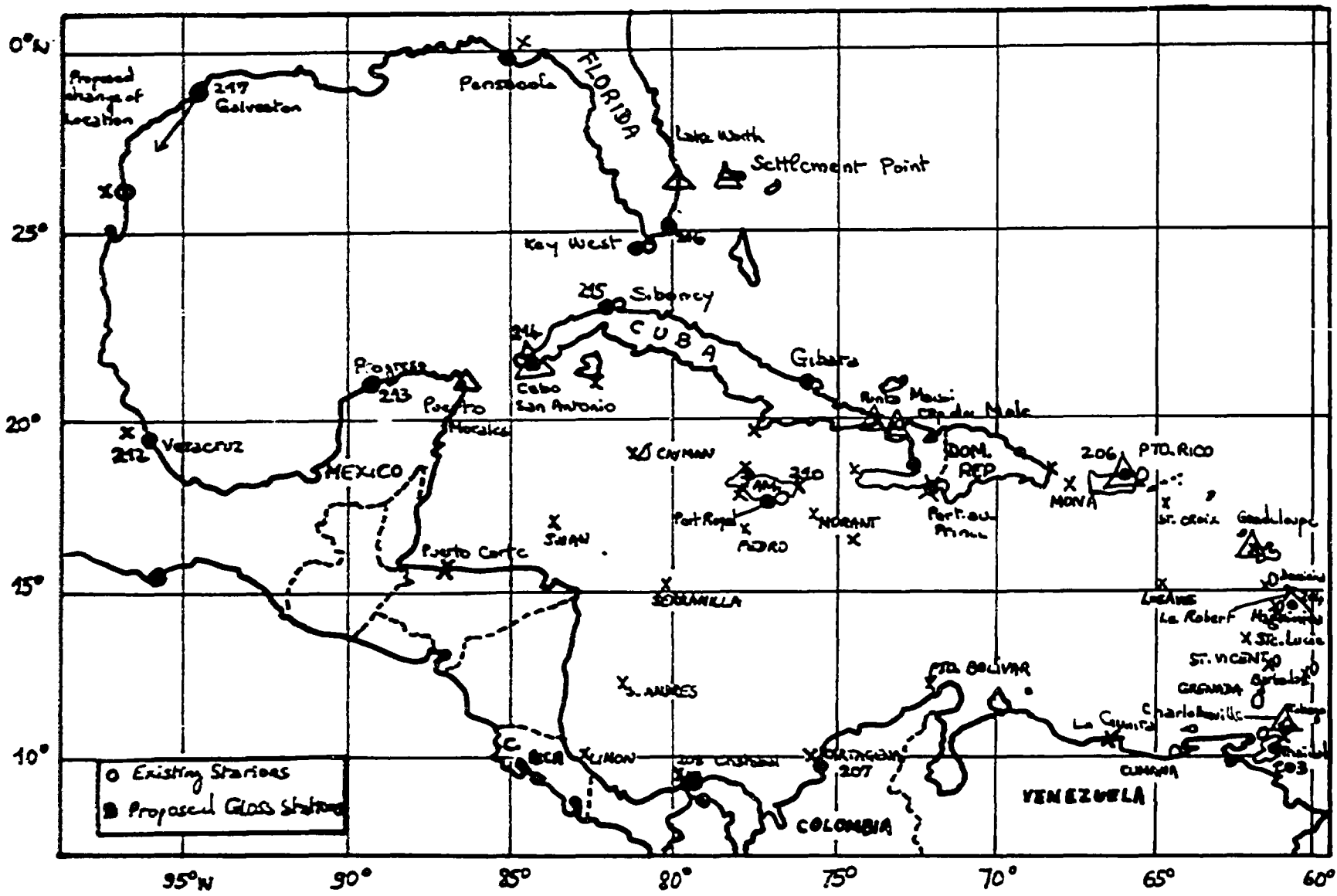

SEA-LEVEL STATIONS IN THE IOCARIBE REGION

ANNEX IX

- △ Proposed pairs of sea-level stations for monitoring inflow/outflow patterns
- X Stations recommended for monitoring other secular changes

Locations of Indian Ports  
For which data supplied to PSMSL

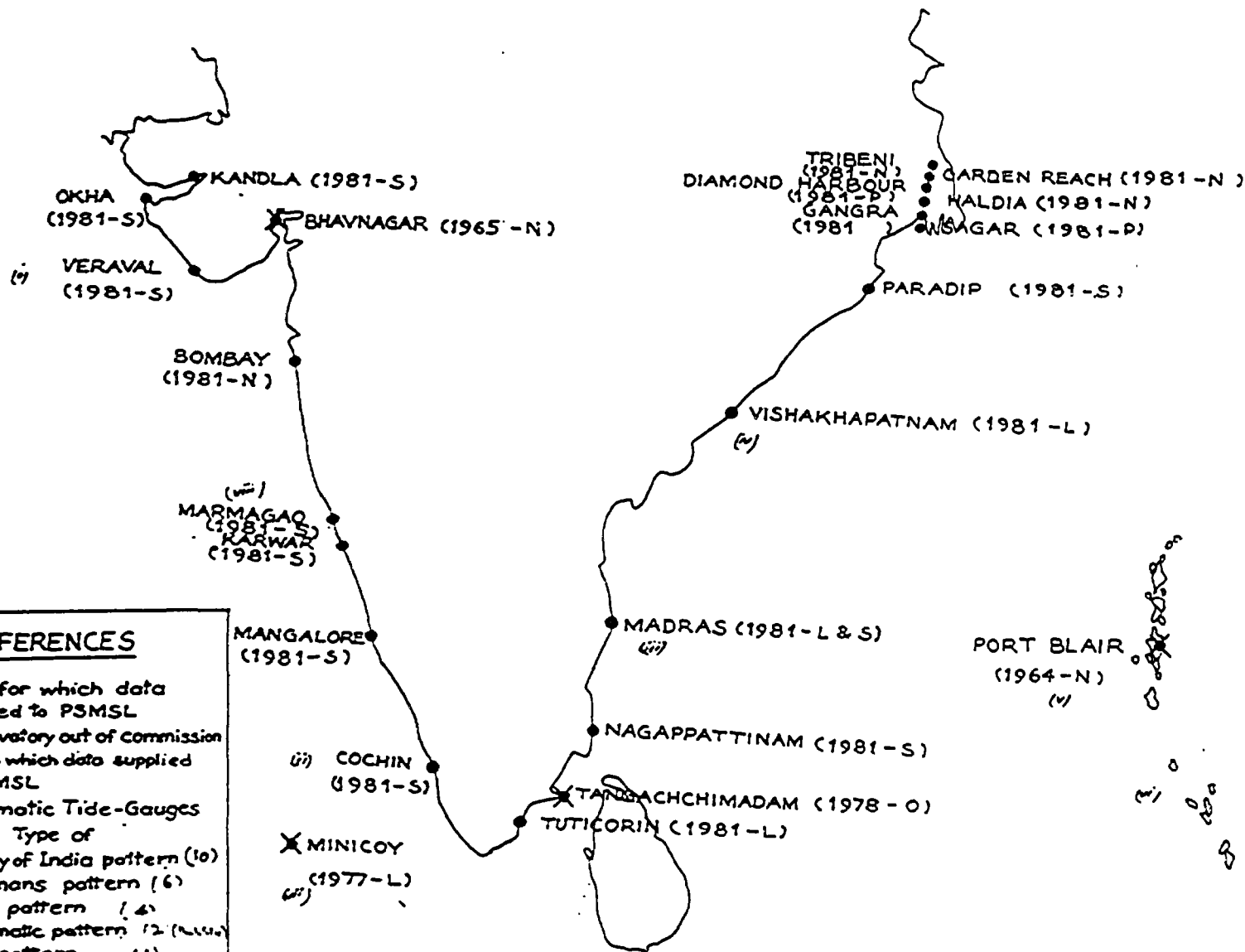

SEA-LEVEL STATIONS OF INDIA

ANNEX X

**REFERENCES**

- Ports for which data supplied to PSMSL
- ✕ Observatory out of commission (Year) upto which data supplied to PSMSL

Automatic Tide-Gauges

Type of

- S Survey of India pattern (10)
- N Newmans pattern (6)
- L Lège pattern (4)
- P Pneumatic pattern (2) (1981-S)
- O OTT pattern (1)

(i) & (iii) Tide gauges selected in the GLOSS list.

ANNEX XI

LIST OF DOCUMENTS

WORKING DOCUMENTS	<u>Title</u>
IOC/GLOSS-II/1	Agenda
IOC/GLOSS-II/2	Annotated Provisional Agenda
IOC/GLOSS-II/3	Summary Report
IOC/GLOSS-II/4	List of Documents
IOC/GLOSS-II/5	List of Participants
IOC/GLOSS-II/6	Progress Report on GLOSS Development since October 1986
IOC/GLOSS-II/7	Activities of International Sea-Level Centres (PSMSL, SOC for ISLPP, TOGA Sea-Level Centre)
IOC/GLOSS-II/8	WCE Sea-level Requirements
IOC/GLOSS-II/9	Requirements for Absolute Geodetic Levelling of Some GLOSS Stations (VLBI/GPS, DORIS)
IOC/GLOSS-II/10	Proposal on the IGOSS Sea-Level Pilot Project for the North Atlantic (INA)
IOC/GLOSS-II/11	IOC Regional Activities Related to GLOSS
IOC/GLOSS-II/12	Draft Work Programme for 1988-1989
IOC/GLOSS-II/13	International GLOSS Co-ordination
IOC/GLOSS-II/14	Outline of the Proposed GLOSS Newsletter

N.B. THIS LIST IS FOR REFERENCE ONLY. NO STOCKS OF THESE DOCUMENTS ARE MAINTAINED.

ANNEX XII

"ASEAN" TIDE GAUGE LOCATIONS

Station	Location	Latitude	Longitude
<u>INDONESIA</u>			
1.	Blang Lancang (Lhoksemawe)	05°13'N	97°06'E
2.	Pasir Panjang	01°07'N	103°20'E
3.	Tarakan	03°17'N	117°35'E
4.	Tarempah	03°15'N	106°15'E
5.	Pontianak	00°05'S	109°16'E
6.	Meneng	08°07'S	114°23'E
7.	Pulau Pari	05°51'S	106°37'E
<u>MALAYSIA</u>			
8.	Tapis Alpha	05°19.8'N	105°29.6'E
9.	Pulau Lakei	01°44.8'N	110°29.6'E
10.	Labuan	05°14.7'N	115°14.5'E
11.	Pulau Layang Layang	07°22.6'N	113°50.4'E
12.	Sandakan	05°48.5'N	118°05.0'E
<u>PHILIPPINES</u>			
13.	Balabac	07°59.3'N	117°03.8'E
14.	San Jose	12°19.9'N	121°05.2'E
15.	Port Irene	18°23.1'N	122°06.2'E
16.	Port Surigao	09°46.9'N	125°29.8'E
17.	Jolo	06°03.5'N	120°59.9'E
<u>SINGAPORE</u>			
18.	Raffles Light House	01°09.6'N	103°44.6'N
<u>THAILAND</u>			
19.	Laem Panwa (Phuket, Andaman Sea)	07°47.0'N	98°24.3'E
20.	Ko Nu (Songkla)	07°14.0'N	100°36.1'E
21.	Laem Thammachat (Trat)	12°10.5'N	102°19.8'E
22.	Ko Mattaphon (Chumphon)	10°26.7'N	99°15.4'E
23.	Ko Samui (Surat Thani)	09°25.0'N	99°55.5'E

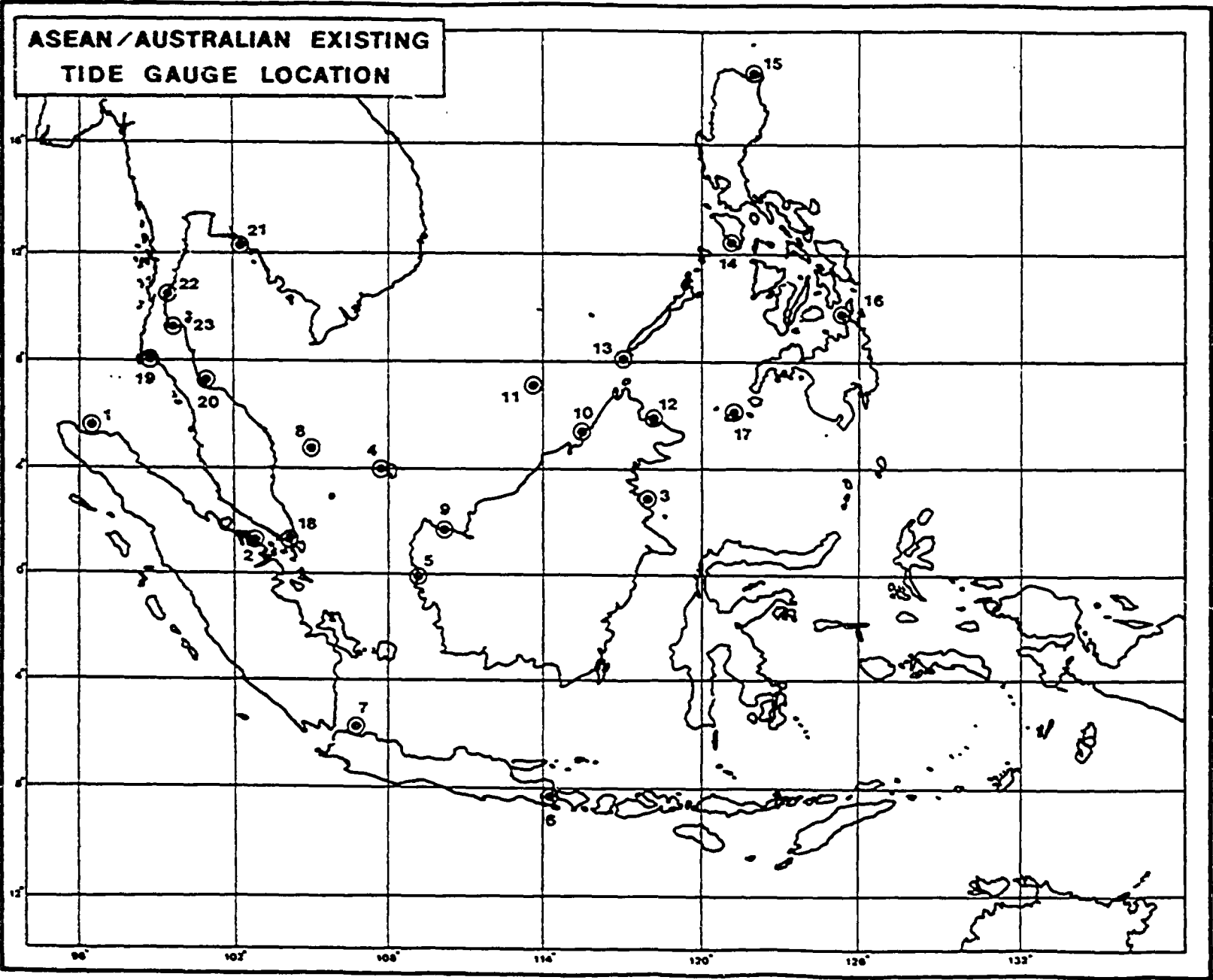

ANNEX XIII

ACTIVITIES OF INTERNATIONAL SEA-LEVEL CENTRES

1. TOGA SEA LEVEL CENTER  
(submitted by Prof. K. Wyrtki)

Realizing the importance of sea level data for research in ocean dynamics and for the monitoring and prediction of oceanographic processes, the Tropical Ocean - Global Atmosphere Project (TOGA) has established a TOGA Sea Level Center at the University of Hawaii. It is the purpose of the center to collect all sea level data in the TOGA area between 30N and 30S during the ten years of the TOGA project, 1984 and 1994, and make them available for research. The TOGA Sea Level Center will also obtain and archive past sea level data for the same region, as long as they are made available from the originators. The importance of sea level data has been enhanced by the need for calibration of satellite altimeters like GEOSAT and for the TOPEX mission planned for WOCE. The creation of GLOSS and the requirements of CCCO for climate monitoring have placed additional emphasis on the value of sea level information. The TOGA Sea Level Center is funded by NOAA through the U.S. TOGA Office. It cooperates closely with NODC.

The scientific requirements of TOGA specify the need for daily mean sea level values at all observing stations. Because scientific study of sea level demands different types of filtering of the original data, the need for daily mean sea level requires the acquisition of hourly or more frequent original data. After acquisition the sea level data are subjected to a stringent quality control before they are filtered and archived.

Data acquisition during the first year of operation of the Sea Level Center has been concentrated on the Pacific Ocean, where an extensive sea level network exists, and where most of the on-going TOGA research is concentrated. During the second year acquisition has been expanded to the Indian Ocean, where a new sea level network is being established for TOGA. In the following years data from the Atlantic Ocean will also be included into the archive.

Data are being made available to scientific investigators in two different modes. Some sea level stations, presently 26, transmit their data by satellite. Data from these stations are available within about four weeks, although they may be subject to later correction to absolute levels. They are contained in Data Set 1.

The TOGA Sea Level Center also handles the preparation of the monthly synoptic sea level maps for the IGOSS Sea Level Pilot Project (ISLPP). As part of this project monthly mean sea level data from 78 stations in the Pacific are also available within one month. These data are contained for the Period 1974 to the present in Data Set 2.



The incoming sea level data are usually received, quality controlled and filtered in batches of one year. At that time they are entered into the data archives. At present we maintain 4 data sets on magnetic tape, which are listed in the appendix as Sea Level Data Sets 3 to 6. Similar data sets have been started for the Indian Ocean and for the Atlantic Ocean. During the last year 34 data requests by various scientists and agencies have been filled.

APPENDIX  
TOGA SEA LEVEL CENTER  
DATA HOLDINGS

A. RAW DATA (Near-Real-Time)

1. Daily mean sea level  
Pacific, 25 stations, magnetic tape  
1984 to present months  
These are satellite transmitted data from the Pacific Sea Level Network. They are preliminary and not fully corrected. Once the Data are corrected they are entered into SEA LEVEL DATA SET 5.
2. Monthly mean sea level  
Pacific, 76 stations, magnetic tape  
1975 to current month  
These are preliminary data received for the monthly sea level maps published for the IGOSS Sea Level Pilot Project (ISLPP).

B. ARCHIVED DATA

3. High frequency sea level values, recorded faster than once per hour.  
Pacific, 32 stations, magnetic tape  
Most stations from 1975 to latest complete year  
These are data from the Pacific Sea Level Network started in 1974 as part of NORPAX plus some additional data.
4. Hourly sea level  
Pacific, island and coastal stations  
76 stations, magnetic tape  
1974 to present, updated in annual increments.
5. Daily filtered sea level  
Pacific, 82 stations, magnetic tape  
Most stations from 1974 to 1985 (few longer), some with gaps  
Final data. Prepared for TOGA
6. Monthly mean sea level  
Pacific, 248 stations, magnetic tape  
From station installation to about 1985, regularly updated

2. SPECIALIZED OCEANOGRAPHIC CENTER FOR THE IGOSS SEA-LEVEL PILOT PROJECT IN THE PACIFIC  
(submitted by Prof. K. Wyrtki)

The increasing interest in the timely availability of sea level information for the monitoring of ocean processes led to a plan to produce monthly maps of sea level topography for the Pacific Ocean. At a meeting of the Integrated Global Ocean Services System (IGOSS) in San Jose, Costa Rica in November 1983 it was recommended to create a Specialized Oceanographic Center (SOC) for the IGOSS Sea Level Pilot Project (ISLPP) at the University of Hawaii under the direction of Dr. Klaus Wyrtki. This center was established in March 1984 by joint action of the Intergovernmental Oceanographic Commission (IOC) and the World Meteorological Organization (WMO). The Government of the United States offered to fund the center for its intended operational period of five years. First year funding was received in May 1984 from the National Oceanographic and Atmospheric Agency (NOAA). Operations of the center started immediately and the first map of monthly mean sea level for the Pacific for June 1984 was published in July 1984. Since that time monthly maps have been issued regularly at monthly intervals. The IGOSS Sea Level Pilot Project is co-located with the sea level center for the Tropical Ocean Global Atmosphere project (TOGA).

The purpose of the IGOSS Sea Level Pilot Project is to make monthly mean sea level data available to users in a timely fashion and to generate products which are valuable for scientific analysis of climate related ocean processes.

In May 1984 Member States of IGOSS in the Pacific were contacted and requested to provide monthly sea level data and past data for selected stations to the SOC in Honolulu. The response was most enthusiastic. By the end of 1984 a total of 25 countries contributed data from 67 stations. As of July 1987 the number of participating countries has increased to 30 and a total of 78 stations participate in the project. Only two countries are not participating. The Soviet Union has never replied to any communication about the project, although it is member of both the IOC and of IGOSS. Taiwan has declared that sea level information is a military secret and will not be released publicly. At present we are attempting to expand the network to cover the Southeast-Asian waters. The monthly maps are published about 28 days after the end of each month. They are distributed to a mailing list of about 140 users, and the national contacts of several participating countries distribute them further. The maps are also reproduced in the monthly bulletin of the Climate Analysis Center of NOAA and in the monthly bulletin of the World Climate Program published by WMO.

At present a report is in preparation, which will provide a description of the program, of the data acquisition, processing and quality control, of the products generated, and will give revised and updated monthly maps for the years 1984 to 1986. This report will also contain monthly maps of sea level anomaly, which originate from the removal of the mean annual cycle, and monthly maps of sea level corrected for the effect of atmospheric pressure.

The SOC also prepares at quarterly intervals an index of upper layer volume for the equatorial Pacific Ocean, which is used as an indicator for the development of El Niño and is reproduced in the Climate Analysis Bulletin of NOAA.

In the coming months we will start to produce and issue maps of sea level anomaly and maps of sea level corrected for atmospheric pressure on a regular basis. We also intend to produce indices of the strength of equatorial currents in the Pacific on the basis of sea level differences between selected stations.

The data from the 78 sea level stations participating in ISLPP are available for the years 1974 to 1986 to interested parties on magnetic tape. They are also part of the data archive of the TOGA Sea Level Center.

3. PERMANENT SERVICE FOR MEAN SEA-LEVEL ACTIVITIES OF PSMSL: 1986 AND 1987  
(submitted by Dr. D. Pugh)

To date the increased data flow to PSMSL as a result of the establishment of GLOSS has been significant rather than spectacular. Priority must now be given to increasing the supply and quality of data.

PSMSL has continued to collect, disseminate, analyse and interpret monthly and annual mean sea levels from gauges world-wide, in accordance with the requirements of its parent body, the Federation of Astronomical and Geophysical Services.

Many organizations supply data year after year on a regular basis, but others supply several years of data in a single block. Recent significant additions to the data bank have been supplied by Greece, Pakistan, the USA, Canada, Yugoslavia and Portugal. Publication of data no longer takes the form of printed books. Up-to-date computer dates are supplied on demand for the areas and periods of interest. As an alternative, data is offered in the form of printed computer output. PSMSL has recently transferred to a new computer system which has allowed the implementation of a more flexible software system for manipulating the data. PSMSL continues to give advice and encouragement to authorities and individuals interested in establishing tide gauges or analyzing sea-level data. Based on annual sea-level courses held at Bidston in co-operation with the IOC, a manual summarizing the basic teaching material for tide gauge installation and data reduction has been published in English, French, Spanish, and Russian. Since the first course was held in 1983, a total of some 20 scientists and technicians concerned with sea-level measurements have received training. During this training, which is supplied by the staff of the Institute of Oceanographic Sciences, participants are familiarized with the work and objectives of PSMSL. An early participant, on return to a senior position in Mauritius, has arranged for the installation of permanent gauges on his island and the adjacent island of Rodriguez.

Dr. Philip Woodworth who became associated with the work of PSMSL in 1983, has undertaken a series of analyses into the global and regional changes of sea level. Papers have been published on the 11-year cycle in European sea levels, and the seasonal variation of sea-level on a global basis. Dr. Woodworth has also analyzed correlations between pairs of sea level stations as a contribution to the debate: "A global sea-level network - How many gauges are enough". This paper undertakes the sort of analysis necessary for the evolution of an efficient and well-tuned GLOSS network. In June 1986, Dr. Woodworth gave a presentation "Measuring the True Mean Level of the Sea Surface" to the Council of Europe Network on Geodynamics Meeting in Belgium. He has also written a paper on "The Data Acquisition of and Trends Observed in Global Mean Sea Level" which will be published in a forthcoming volume on "The Impacts on Sea-Level Rise on Society". Although the primary responsibility of PSMSL remains the steady accretion of data and its dissemination, the development of data analysis and interpretation is a proper aspect of PSMSL, within the requirements of members of the Federation of Astronomical and Geophysical Services. Over the next 4 years it will be proper to define and develop products based on the data collected.

Following the Vancouver meeting of IUGG in August 1987, the advisory role of the IAPSO Committee on Tides and Mean Sea Level in the development of PSMSL has been taken over by a new Commission on Mean Sea Level and Tides. The upgrading of this Committee to an IAPSO Commission and the title change both reflect the growing importance of mean sea level for scientific studies. IAPSO was encouraged to learn of the development of GLOSS, and a special IUGG resolution was passed encouraging authorities to measure sea level to standards needed for scientific studies. Some scientists noted that measurements submitted to PSMSL were not always of sufficient quality to allow detailed interpretation. PSMSL and GLOSS were urged to pay attention to the accuracy of measurements as well as the total quantity of measurements which are available.